

June 2015

CAN *Newsletter*

Hardware + Software + Tools + Engineering

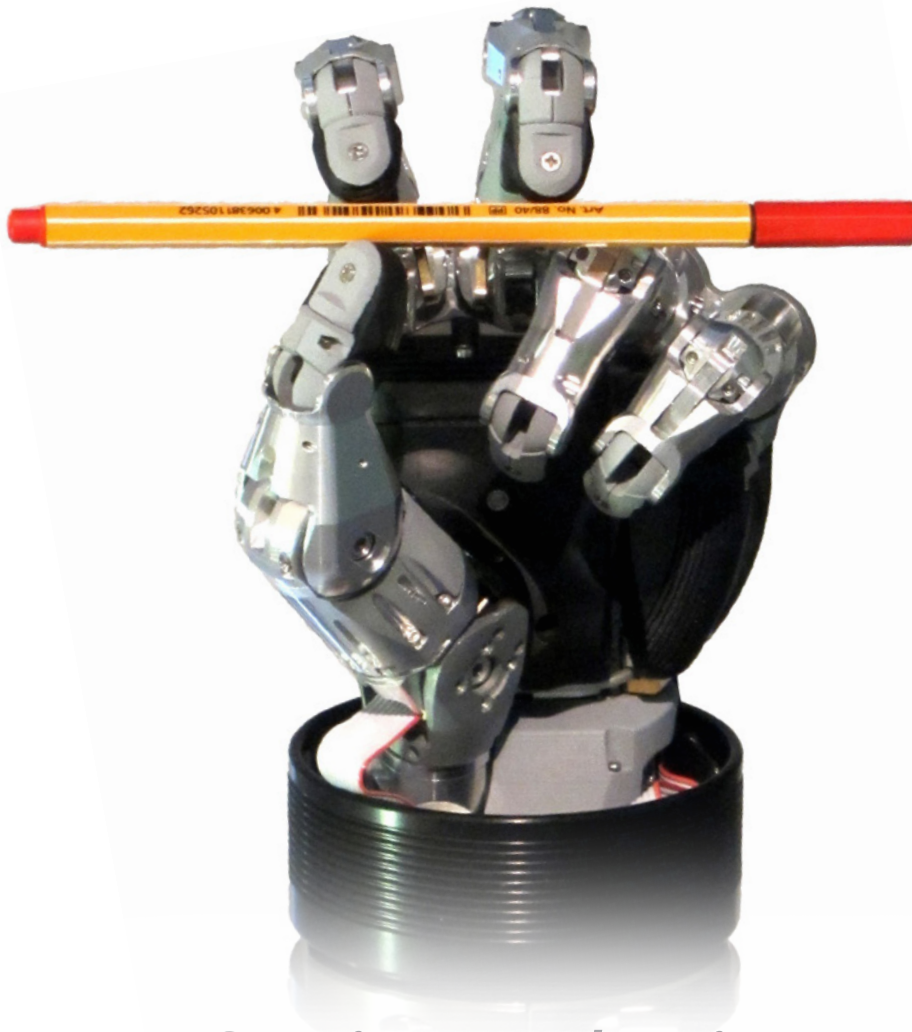

Concierge and assistance robot

Rise of the service robots

The elephant of off-highway vehicles

E-quad: driving e-mobility forward

Actuators



Hardware & Software for CAN / LIN Bus Applications

■ PCAN-GPS

Programmable Sensor Module with CAN

The PCAN-GPS is a programmable sensor module for position and orientation determination. The sampled data can be transmitted on a CAN bus and logged on the internal memory card.

- NXP LPC4000 series microcontroller (ARM Cortex-M4)
- Receiver for navigation satellites u-blox MAX-7W
- Bosch BMC050 electronic three-axis magnetic field sensor and three-axis accelerometer
- Gyroscope STMicroelectronics L3GD20
- High-speed CAN channel (ISO 11898-2)
- microSD™ memory card slot
- Wake-up by CAN bus or by separate input
- 2 digital inputs (high-active)
- 1 digital output (low-side driver)
- LEDs for status signaling
- Connection via a 10-pole terminal strip (Phoenix)
- Voltage supply from 8 to 30 V
- Extended operating temperature range from -40 to 85 °C (with exception of the button cell)
- New firmware can be loaded via CAN interface

■ PCAN-Explorer 5

Universal CAN bus monitoring software

The PCAN-Explorer 5 is a comprehensive Windows software for monitoring and analyzing CAN data traffic.

- Simultaneous connections to multiple networks (connected via the same hardware type)
- Clear display of the CAN traffic with various information
- Configurable symbolic message representation
- Data logging with tracers and the 4-channel Line Writer
- Multiple flexible filters
- Easy message transmission
- VBScript interface for the creation of macros
- Supports Windows 8.1, 7, Vista (32/64-Bit)
- Functionality upgrades with add-ins:
 - **Plotter Add-in:** Recording and graphical representation of multiple signal sequences
 - **Instruments Panel Add-in:** Representation of digital and analog signals via graphical instruments for easy simulation of complex CAN applications
 - **J1939 Add-in:** Support for all functions of the SAE J1939 network protocol
 - **CANdb Import Add-in:** Import of CANdb files



www.peak-system.com

Take a look at our website for the international sales partners. Scan the QR code on the left to open that page.

PEAK-System Technik GmbH

Otto-Roehm-Str. 69, 64293 Darmstadt, Germany
Phone: +49 6151 8173-20 - Fax: +49 6151 8173-29
E-mail: info@peak-system.com

PEAK
System

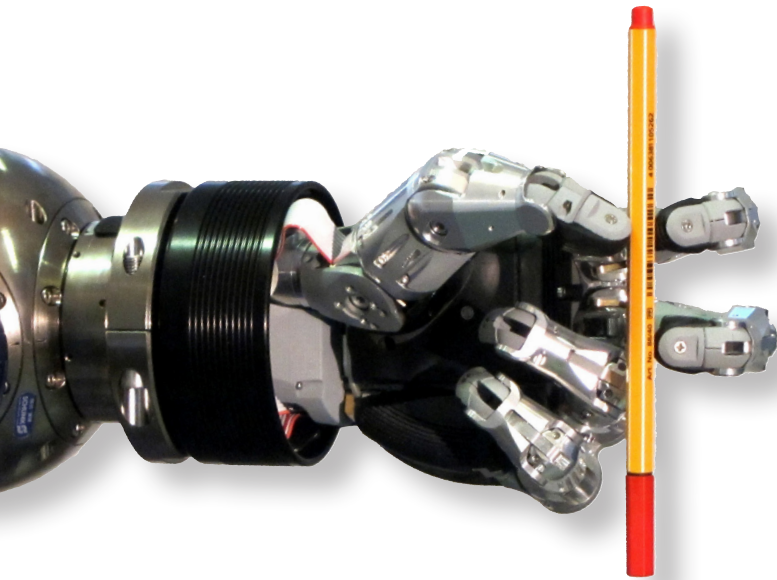

Cover story

The market for service robotics is growing. Service robots have been employed in industrial settings for many years, with a steep increase in recent years. Service robots for domestic use are still under development, but they are catching up.

Imprint

Publisher

CAN in Automation GmbH
Kontumazgarten 3
DE-90429 Nuremberg

publications@can-cia.org
www.can-cia.org

Tel.: +49-911-928819-0
Fax: +49-911-928819-79

CEO Holger Zeltwanger
AG Nürnberg 24338

PDF subscribers: 3291

Editors

pr@can-cia.org

Annegret Emerich
Cindy Weissmueller
Holger Zeltwanger
(responsible according
to the press law)

Layout

Nickel Plankermann

Media consultants

Julia Dallhammer
Gisela Scheib
(responsible according
to the press law)
Meng Xie

Distribution manager

Julia Dallhammer

© Copyright

CAN in Automation GmbH



Applications

Concierge and assistance robot	4
The elephant of off-highway vehicles	8
Filtration process for improved drinks	20
Rise of the service robots	30
Round the world with a green motorbike racer	32
E-quad: driving e-mobility forward	34



Engineering

CAN timing analysis beyond bus load	10
Electronics first – or housing?	14
Optimized run time behavior	18
Connecting automotive standards	24
Developments in China increase	28

CAN Newsletter subscription

The CAN Newsletter appears four times a year, in March, June, September, and December. It is free of charge. Please feel free to forward it to colleagues, customers, and anybody else interested in CAN.

[CAN Newsletter subscription form \(pdf\)](#)

Concierge and assistance robot

Assistance robots are still very much in development, but Hollie already has the basics down: it manages complex tasks and supports people in everyday situations. The robot can even reach the floor by bending its body forward.

Hollie is a mobile, bi-manual service robot that was developed at the FZI (Forschungszentrum Informatik) Karlsruhe as part of the “House of Living Labs” (Holl). In the future, the robot will carry out different tasks within the Holl, for example accompany visitors and provide assistance. It comes as no surprise, then, how we arrived at the robot’s name: Hollie is an acronym for “House of Living Labs intelligent Escort“. With the help of speech synthesis software, a microphone array and an LED-based information system within the body, the robot offers possibilities for human-machine interaction that go beyond simple information services. New tasks can be commanded to the robot via 3D gesture recognition. This also enables users to teach Hollie new trajectories, as the robot can mimic and store human motion sequences.

During the design phase of the service robot Hollie, the focus was on human-robot interaction as well as the robot’s practical usability for a human user. From these requirements we derived the proportions and kinematic structure of the robot’s body as well as the design of the outer hull with its round and friendly geometries. Wherever possible, we applied robust industrial components in the construction. Accordingly, almost all actuators come from Schunk: Two LWA 4p light-weight robotic arms made with Powerballs with CANopen interfaces are employed as manipulator arms and the neck is also made of a Powerball. The upper body is actuated by two Schunk PRL 120 high-torque rotary modules, which are supported by springs when the body is close to maximum deflection. This is the case when the robot leans forward to reach objects on the floor. The shoulder axis that carries the arms and the neck is kept in a horizontal alignment by a parallelogram system of levers within the body. This parallelogram system also relieves the upper body actuators from the torques generated by the arms when they are stretched out forwards or backwards. Currently Hollie is equipped with two anthropomorphic servo-electric 5-finger gripping hands (Schunk SVH) that allow maximum flexibility when grasping and manipulating everyday objects.

The mechanical structure of the body allows Hollie to reach the ground with its hands in a way that is similar to humans. Grasping objects from the floor is a major requirement for a robot if it is meant to be a real help for people with physical handicaps. Therefore, Hollie is able to autonomously locate and fetch dropped keys or pieces of clothing. On the other hand, the body kinematic allows the robot to reach high shelves or windows when stretched up. The robot then has a shoulder height of 124 cm, which is sufficient for example to get dishes from an upper kitchen

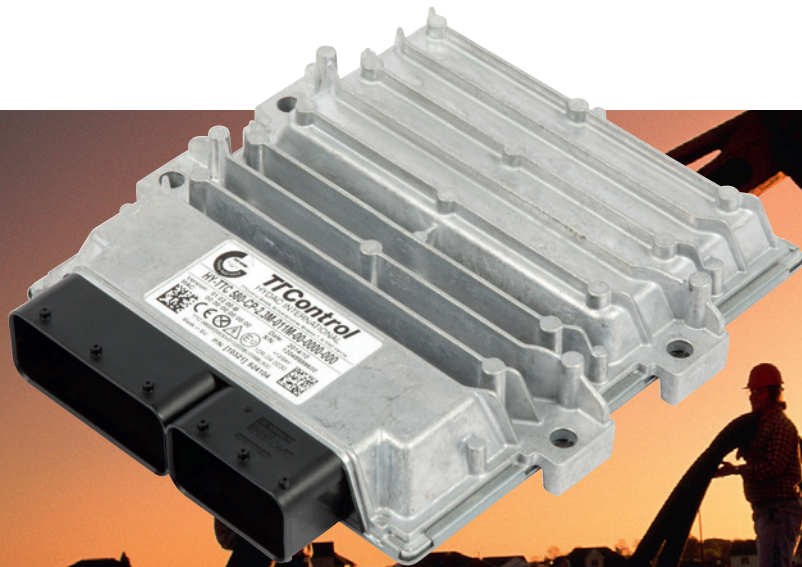

Figure 1: Hollie performing an interactive dexterous manipulation task (Photo: FZI)

cabinet and set the table. And that is in fact one of the main application scenarios for the robot: To unburden service staff from repetitive tasks like setting or cleaning the table, for example in an elderly care center, escorting people in public places like in a museum, or executing mobile pick and place tasks in shop-floor logistics applications or industrial environments. For that, Hollie has a mobile platform with an omni-directional drive system from Segway, which is controlled by the central computer via a CAN interface.



Figure 2: To relieve elderly care personnel from repetitive tasks, Hollie can set the table (Photo: FZI)



Powerful Control Units for High-Safety Applications: HY-TTC 500 Family

Flexibility & Usability

- Single controller for whole vehicle for centralized architectures
- Extensive I/O set with multiple software configuration options per pin
- Open programming environments C, CODESYS® V3.x and CODESYS® V3.x Safety SIL 2

Safety

- TÜV-certified according to IEC 61508 (SIL 2) and EN ISO 13849 (PL d)
- ISO 25119 AgPL d certifiable
- CODESYS® Safety SIL 2 including support for CANopen® Safety Master and easy separation of safe / non-safe code
- Safety mechanisms in hardware to minimize CPU load
- Up to 3 output groups for selective shut-off in case of safety relevant fault
- Safety companion and safety mechanism in hardware

Connectivity

- Up to 7 CAN interfaces
- Automatic baudrate detection and configurable termination for CAN
- Ethernet for fast download and debugging purpose

Performance

- 32 bit / 180 MHz TI TMS570 dual core lockstep processor (ARM architecture)
- Up to 2.3 MB RAM / 11 MB Flash
- Floating-point-unit

Robustness

- Automotive style housing suited for very rough operating conditions
- Total current up to 60 A

www.ttcontrol.com/HY-TTC-500-Family



Safety Certified ECUs



General Purpose ECUs



I/O Modules



Safe I/O Modules



Operator Interfaces

Two Sick laser range finders with a 270-degree field of view each are mounted on opposing corners of the platform, slightly above the wheels. The laser range data is used for navigation purposes as well as for collision protection. A software package that has been deployed in autonomous unmanned transportation systems for hospitals for over ten years now allows Hollie to navigate in all environments without requiring any structural modifications or markers. The robot is small enough to maneuver in any building that is suitable for wheelchairs.

The delicate outer appearance of the robot deceives about its weight of 160 kg. Within a footprint of around 80 cm x 80 cm, batteries, two computers, network equipment, sensors, and a total of 61 movable axes are located. Of these 61 axes, 38 are individually actuated.

To achieve an appealing form language of the outer paneling without restricting the functionality of the robot, we made use of large, individually designed 3D-printed parts. Also, the head hull, which acts as a mount for a stereo camera system, an RGB-D sensor, and various microphones, was completely printed in two parts via Laser Sintering. The front and back panels of the body are covered

with fabric, as they have to be flexible when the body is bending. Hollie's human-like appearance invites users to interact with the robot while it is still far enough from being too humanoid, as this can be perceived to be creepy – roboticists know this phenomena as the "Uncanny Valley".

Hollie is able to recognize persons via face detection algorithms. Combined with the anthropomorphic upper

body, this enables a broad field of application scenarios: Starting with the motivation for physical training of older people (the robot demonstrates Tai Chi exercises), to the usage as an embodied telepresence system (the robot represents the contact person), and last but not least as a mobile nursing assistant (the robot patrols a building, reaches patients by opening doors, and uses elevators).

The energy supply of the robot is built of four lithium-polymer rechargeable batteries, which power the mobile platform and all on-board electronic devices, except the logic and power stages of the upper body actuators, including the arms and hands. These are fed from an additional lead acid gel battery.

A switch-over-circuit allows the charging of all batteries during operation and the seamless switching between external and internal power supply while in operation.

The total number of 38 actuators is controlled by an architecture consisting of two computers that are interconnected via Gigabit-Ethernet. The internal network also connects the two laser range finders and a Wifi bridge. A high-performance Linux Quad-Core embedded computer handles the sensor-data processing, the navigation, and the motion planning. The second embedded system is a dedicated interpolation computer, responsible for the low level control of all actuators. Therefore, it is equipped with four CAN interfaces: The Segway platform requires two separate CAN networks, the other two buses run a CANopen protocol and control twelve arm nodes plus four additional nodes in the torso and neck modules. Also, two serial EIA-485 buses are required for the two Schunk SVH hands, which each possess nine current-controlled degrees of freedom.

The real-time control and the low-level hardware abstraction layer are implemented in FZI's own MCA2 robot control framework, written in C++. The event-based high-level software was composed in the open source framework ROS (Robot Operation System) and contains C++ and Python nodes. Both frameworks are network transparent, so that single function blocks can also be run off-board.

A detachable tablet computer on the robot's back as well as a speech-dialogue system can be used to command tasks.

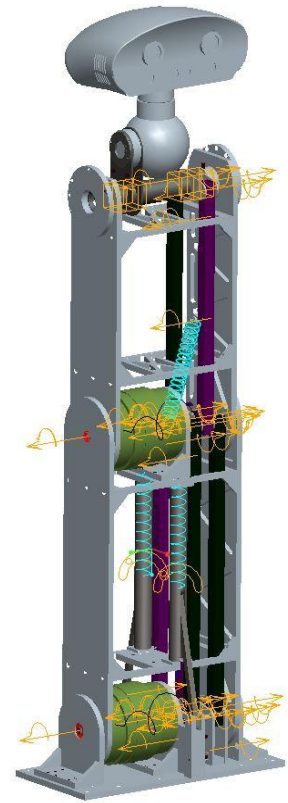

Figure 3: Mechanical structure of the upper body that allows the robot to bend forward (Photo: FZI)



(Photo: FZI)



Figure 4: Human-sized servo-electric 5-finger hands from Schunk allow Hollie to grasp and manipulate objects (Photo: FZI)

The robot is also equipped with a full color LED-ribbon that runs around the mobile platform and which is used to signal driving intentions or the direction and distance to an obstacle that blocks the task execution.

Another full color LED-badge in the chest of Hollie visualizes the overall system status, which includes the battery status or the degree of autonomy.

Recently, the robot was equipped with a 3D collision detection system that runs on a GP-GPU (General Purpose Graphics Processing Unit). The system processes and interprets point-cloud data from Hollie's 3D camera and does a live motion prediction of all moving obstacles in the surroundings. These predictions are taken into consideration while planning the robot's motions. The algorithms are fast enough to plan collision-free trajectories in dynamic environments without noticeable delays. Thus, the robot can even be employed in close proximity to humans and safely execute its assigned tasks.

Altogether, Hollie is a flexible and innovative service robot that can be used as a research platform for a manifold of research aspects. Numerous demonstrations and exhibitions on fairs have demonstrated the practical usability and stability of the industrial components as well as the potential of FZI's robotics software. ◀

Author



Andreas Hermann
 FZI Forschungszentrum Informatik
www.fzi.de
hermann@fzi.de

Related links

[Hollie picks up laundry from the floor](#)
[Over hill, over dale: The six-legged robot does wander everywhere](#)

POSITAL

FRABA

SENSORS FOR MOBILE MACHINES



Absolute Rotary Encoders and Inclinometers

Reliable Measurement under Harsh Conditions

High Protection Class: IP69K

Fieldbus and Analog Interfaces

Safety and ATEX

Ex-Proof Versions Available

Successfully Integrated in
 Concrete Pumps, Drilling Machines,
 Working Platforms, Cranes, Wheel Loaders,
 Leader Masts and More

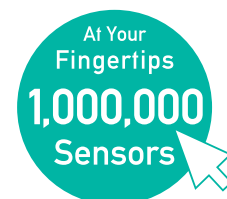

www.posital.com

POSITAL
 Germany, Singapore and USA
www.posital.com, info@posital.com

The elephant of off-highway vehicles



(Photo: Fendt)

Micro-controller based and in a robust housing, the 8960 actuator series by Sonceboz is like an elephant. It was specially developed for transmissions in off-highway vehicles.

Agricultural and construction machinery is becoming increasingly complex. Today, motors and components do not only need to have the essential attributes but they are also increasingly required to have additional analytical and diagnostic functions. They must also be able to withstand the harshest environmental conditions. Intelligent actuators such as the 8960 smart actuator series by Sonceboz are the answer.

Maximum resistance to mechanical, magnetic, and thermal loads as well as to weather conditions and moisture: components in agricultural and construction machinery in particular must rise to these challenges - without compromising functional safety, performance, or precision. The robust actuators from Sonceboz, featuring clever electronics and corresponding interfaces, have been designed to meet the requirements of harsh environments and can thus provide increased efficiency, safety, and comfort for off-highway machines. Thanks to their electronic systems and the corresponding interfaces, they can be used as self-sufficient components within the system of a mobile machine.

The biggest challenge when developing the 8960 actuators was to guarantee high positional precision and reproducibility in any situation. The challenging environmental conditions to which the components in agricultural machinery are exposed have increased the complexity of the developmental process. Reactive forces complicate position holding enormously. In order to guarantee the position even under these conditions, a dynamic torque of more than 2,5 Nm is essential. At the same time, the residual torque when inactive should not fall below 1 Nm. That is

why Sonceboz uses a hybrid stepper motor with 200 steps per rotation. Even at low speed, the motor can provide high torque, ensuring the necessary failsafe functions thanks to its minimal residual torque.

Reliable even in the harshest conditions

The 8960 series is particularly well suited for use in CVT (Continuously Variable Transmission) transmissions in tractors. This actuator can handle dirt, vibration, and extreme temperatures. Fastened to the outside of the transmission housing on the tractor, it has already been tested under the harshest conditions. In the CVT transmission, the system must respond quickly and accurately to a position signal. The actuator acts as the connection between the electronic transmission controller and the hydrostatic split transmission. Drivers use their joysticks to give the drive command from the driver's cab and the tractor's ECU then transmits the command to the actuator via CAN. The actuator then converts it into mechanical actuation in the transmission. In other words, it independently converts the CAN command into a precise angular position and thus determines the angle of the axial piston pump in the power unit. Meanwhile, a redundant control system ensures the reliability of the actuator.

Availability thanks to OBD

In the series, various measuring and testing routines of the intelligent control system ensure safety and

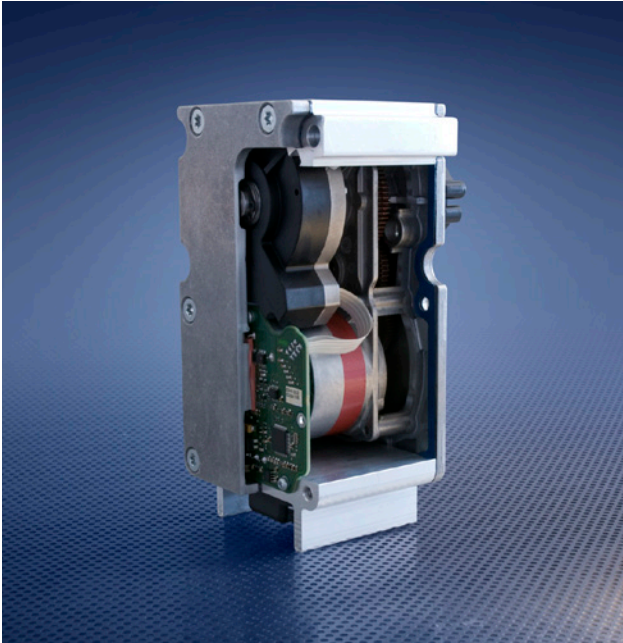

The 8960 smart actuator series (Photo: Sonceboz)

reliability. They enable on-board diagnostics via the CAN interface as required. Using a magnetic and optical sensor with a resolution of 8000 steps/rotation, a redundant measuring system controls the precise positioning of the output shaft. If the output shaft is blocked, the OBD (On-Board Diagnose) initiates a quick diagnosis and sends feedback to the unit. The unit responds by independently reducing the speed and increasing the torque for a short period of time to overcome the mechanical hurdle. The diagnostic system also detects critical situations when it comes to environmental temperature, supply voltage and power consumption. If necessary, the system switches to a reduced operating mode and independently sets priorities to guarantee the safety of the drive.

Sonceboz specializes in the development of innovative solutions for challenging drive problems. The core area of expertise of the Swiss company is integrating electronics, motors and mechanics. The company has years of experience in the mechanical and electronic development of actuators, particularly those used in harsh environmental conditions. One of the particular strengths of Sonceboz is the development of individual, efficient drives based on a comprehensive and modular standard product range. Vibrations, dirt, moisture, temperature fluctuations, tight space constraints, and adaptation to a wide variety of control electronics and communication systems are all just part of everyday life for the Swiss company. ◀

Author



Herbert Trummer
 Sonceboz SA
www.sonceboz.com

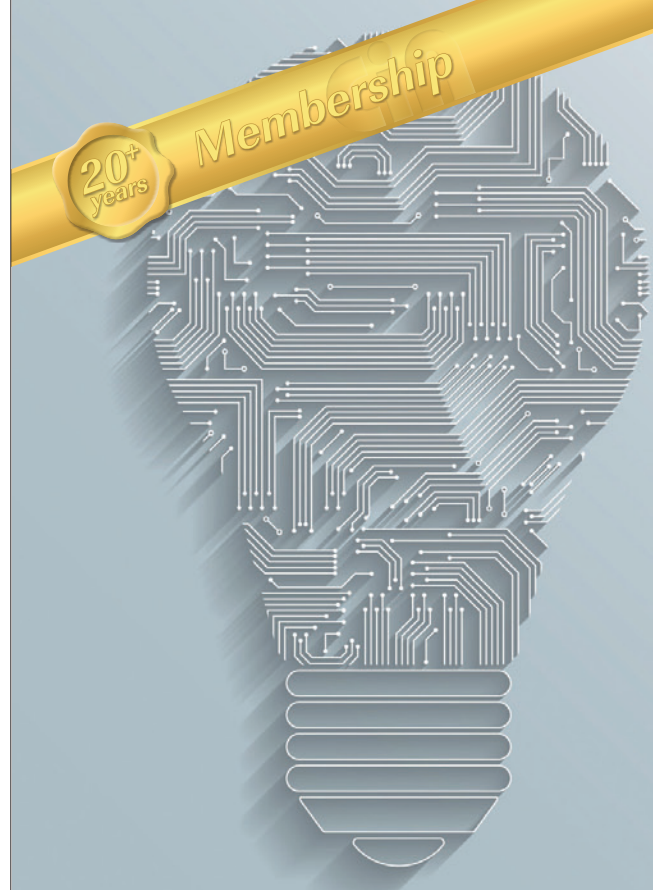

**Von der Idee
 bis zur Serienfertigung –
 ostwestfälisch bodenständig
 Engineering in Echtzeit**

Steuergeräte für Sonderfahrzeuge
 CAN Bus · LIN Bus · Automotive
 Flash Loader · Class-D Verstärker
 Mess- und Prüfgeräte

- **Entwicklung und Fertigung von Geräten und Komponenten**
- **Hardwaredesign, Leiterplatten- und Firmwareentwicklung, Testsysteme für Validierung und Serie**
- **Entwicklungsunterstützung EMV, Pflichtenhefte, Ultra-Eil-Entwicklung**

Freitag
 Elektronik und Systeme

Dipl. Ing. Jan Freitag
 Elektronik u. Systeme
 Sudbrackstraße 38
 33611 Bielefeld - Germany

Tel. +49 (521) 2701093
 Fax +49 (521) 2701094
 info@freitag-elektronik.de
 www.freitag-elektronik.de

CAN timing analysis beyond bus load

CAN will keep playing a major role in future automotive network development – and CAN timing analysis has become a core competence. We take a look at the most important use cases.

Modern cars contain 50 and more electronic control units (ECUs) that execute a variety of classical and novel functions in all domains: engine control systems, body electronics, active suspension, electro-mechanical steering, adaptive cruise control, and the latest advanced driver assistance systems (ADAS). These functions are realized through large amounts of software and a host of complex sensors and actuators that exchange more communication data than ever before. Over the years, the electric/electronic (E/E) architecture has become something like an in-vehicle IT infrastructure for the realization of innovative functions, with the communication network at its core. And despite the introduction of higher-bandwidth protocols Flexray and Ethernet, CAN still plays (and will play, especially with CAN FD) a dominant role.

Incremental, evolutionary network design

Network architectures are constantly being modified and extended. With every new function or function update, additional data signals must be integrated for the next version of a car model. These new signals are either placed in existing CAN messages (if there are sufficient bits left) or new CAN frames with suitable CAN IDs and cycle times. Such extensions and modifications appear continuously as new functions are developed. At predefined dates (for instance every six months) the network architecture team (usually a dedicated entity at each vehicle manufacturer) integrates all modifications and releases a new network configuration to be used in future production car models. In other words, the networks grow evolutionarily. Once set, the signals, their mapping, and the CAN IDs and cycle times are usually not changed in later updates. This ensures compatibility with existing components.

Another important requirement is that the real-time capability of the network and its configuration must be maintained. New signals must not distort the existing signals beyond their critical limits in terms of signal latencies and message cycle time jitters. This means that for every change or change request, we must ensure that the timing is not compromised by that change. Moreover, the entire network update can

only be released when we have approved all changes. Otherwise, we must go back one step, change and optimize the placement of new signals into the existing configuration, and re-approve that change. The approval step is a critical one. A bad decision here might falsely reject reasonable changes or worse, result in the release of a network specification that does not work.

Timing analysis beyond bus load

Therefore, leading car manufacturers such as BMW, Daimler, Volkswagen, General Motors, Fiat Chrysler, and many others have established systematic real-time assessments of their network configurations that go far beyond the overly simplistic bus load approach. In fact, the bus load is easy to calculate: divide the message length by the message cycle time, then add these values over all messages, and finally divide the result by the bit speed of the bus. Spreadsheet tools do this easily and approval metrics such as “no more than 50 % bus load” are easy to apply. However, the bus load criterion has crucial limitations. First, it only considers cyclic frames in a proper manner but

has difficulties in capturing the dynamic behavior of event-triggered frames. And second, the bus load criterion does not support network designers in selecting good signal-to-frame mappings and CAN IDs, simply because these decisions have close to zero impact on bus load calculations. To address this critical weakness of the bus load approach, the mentioned companies have done a paradigm change towards more expressive timing metrics where the timing behavior of individual signals and messages are the focal point.

The response time analysis is among the most important metrics. The response time of a message is the time that elapses between the queuing time of the message in the sending ECU until the reception of the last bit at the receiving ECU (see Figure 1). This way, the response time is a real, physical timing attribute of the traveling bits and bytes, and it covers the arbitration delay (the time until a message “wins” the arbitration), which has a dominant effect on the latency of lower-priority CAN messages and all contained signals (see Figure 2).

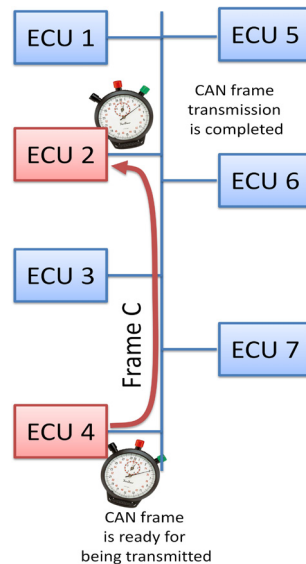

Figure 1: The frame response time is measured starting when the message is queued in the sender's CAN driver buffer until the transmission of the last bit to the ECU2 has been completed (Photo: Syntavision)

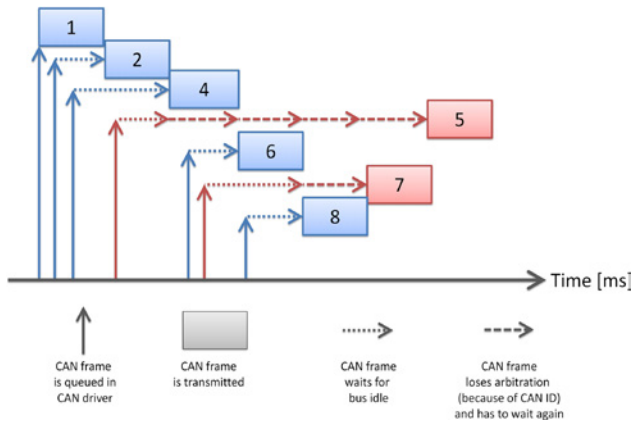

Figure 2: Timing diagram of CAN network with focus on arbitration delays (in red) (Photo: Symtvision)

This arbitration delay varies dynamically. It is very short (or zero) when a message is sent via an empty (or idle) bus, and it can be very long during a burst of high-priority CAN traffic. These variations lead to varyingly effective (or observed) cycle times of individual messages, also called message jitters. If these latencies and jitters become larger, the receiving functions process signal data of different age. And if these variations become too large, the functions cannot run correctly any longer.

BMW has recently published a survey about its timing-enhanced E/E development process [1], which contains a detailed response time analysis at two important process steps: the change request approval and the network

release approval. BMW requires message response times (and subsequently the latency of all contained signals) not to exceed a certain portion of the message cycle time. Fiat [2] has published the same approach with two criteria: the cycle time is used as the hard deadline which must never be broken, and a 20 % cycle time is used as the soft deadline for which violations can be accepted at a certain statistical percentage.

Model-based CAN timing analysis with Symta/S

One crucial precondition for the effectiveness of these approval metrics is that they must be applied before the change requests are accepted and essentially before a new CAN configuration is released. Otherwise, we are unable to detect latency and jitter violations and incorrect system behavior before the integration testing, which is far too late. In other words, we must be able to predict or calculate the expected message latencies based on the configuration alone, without having the test data. And while the bus load can be calculated easily, response time calculations are complex and require tool support. Therefore, many leading car manufacturers including BMW and Fiat use Symtvision's timing analysis tool Symta/S as part of the response time analysis for their approval process, illustrated in Figure 3.

SymTA/S takes the CAN configurations as input in formats such as DBC or Autosar XML (system template), runs ▶

We live electronics!
We live electronics!

sontheim
Industrie Elektronik GmbH



- ▶ 32bit controller with 3x CAN, Wi-Fi, Ethernet, optional I/Os, built-in diagnostic functions and a webserver interface
- ▶ Future-proof freely programmable and real-time capable ECU system
- ▶ Record CAN-messages on built-in NAND-Flash-Memory of up to 16GB
- ▶ Designed for harsh environments: IP69k, heat cycle and vibration tested according to the Automotive EMC Directive
- ▶ Temperature range up to 85°C
- ▶ Searching for a matching diagnostic tool?
<http://www.s-i-e.de/en/products/diagnostics/mdt>

COMhawk® - the On-Board system for efficient telematics and diagnostics

This high-performant electronic control unit has numerous applications for communication and diagnostics on machines including its use as a CAN-to-Wi-Fi Gateway, data server, telemetry node, data logger or diagnostic device.

automotive testing expo 2015 europe
Automotive Testing Expo 2015
16.06 - 18.06.2015
Hall 1, Booth 1566

Sontheim Overview and Portfolio:

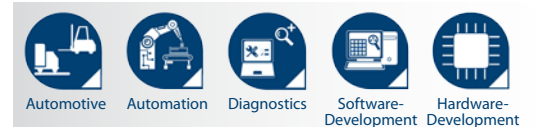

We live electronics!
www.sontheim-industrie-elektronik.de

DE Sontheim Industrie Elektronik GmbH
Georg-Krug-Str. 2, 87437 Kempten
Tel: +49 831 57 59 00-0 - Fax: -73
info@s-i-e.de

US Sontheim Industrial Electronics Inc.
One West Court Square, Suite 750
Decatur, GA 30030
Phone: +1 (404) 494-7839 - Fax: -7701

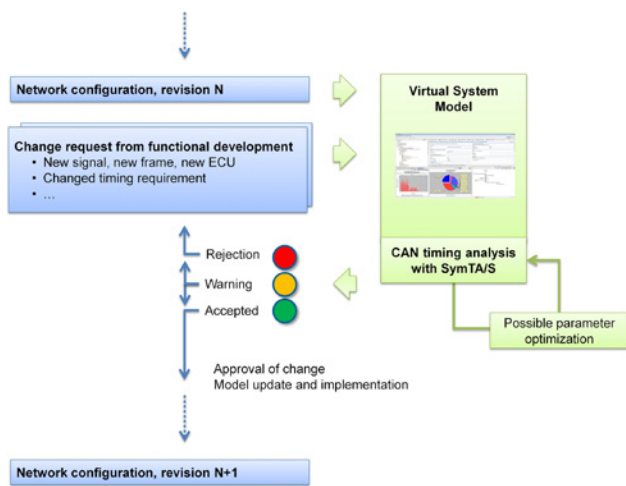

Figure 3: Timing analysis and approval in incremental network design (Photo: Syntavision)

simulations (and optionally a mathematical worst-case analysis) of the timing behavior, determines the relevant message response times, and outputs two-level reports:

- ◆ A quick go/no-go (or green-yellow-orange) report indicates the general real-time feasibility of the given network configuration,
- ◆ A more detailed report visualizes the response times and the fulfillment of the requirements (deadlines and jitter constraints) and provides direct feedback for promising adjustments and optimizations.

Additionally, the model-based timing analysis lets us run before/after comparisons of all involved signals and messages. This lets us track the response times over the network architecture lifecycle so that we can detect bottlenecks early and take appropriate counter measures.

Reserves for future extensions

This brings us to the next application of CAN timing analysis, which can be seen as a virtual variant of the two aforementioned ones: the estimation of future extensibility. It is clear that with every signal that we add to an existing CAN configuration, we reduce the probability that any more signals can be added in the future. As part of a systematic lifecycle management, we should therefore keep track of the remaining reserves. And we should do so not only in terms of currently unused bus load. This would provide us with only little practically relevant information because we usually do not add a percentage of load, but rather we add signals. Therefore, the question is: How many signals of which type and cycle time can we add to the CAN network without breaking the existing requirements? In other words: How robust (or sensitive) is the current configuration against future changes?

We can answer this question by making certain assumptions on future change requests (for instance, one 50-ms message with a 4-byte payload from each ECU on the bus) and then (virtually) check if such a CAN network would still meet all timing requirements. If it does, we have proven that additional signals can be added as long as they are compatible with our assumptions. If not, we know that the remaining reserves are less than what we have asked for. Evaluating different sets of assumptions (that differ in signal size and cycle time, and CAN ID ranges) provides us with additional acceptance criteria for newly

arriving change requests. It is obvious that a timing analysis based on a model (and not its realization) is ideal for such types of virtual “what-if” evaluations.

In practice, we observe two slightly different versions of this use case. The first one generally handles all real change requests according to the incremental design use cases explained above, and afterwards determines the future extensibility mainly for tracking reasons. The other one already includes the additional, virtual change requests before the real change requests are evaluated, thereby approving any change only if it keeps the remaining reserves above a certain limit. The best choice depends a bit on the overall network strategy and usually must be discussed individually.

Major network architecture update

So far, we have focused on the detailed CAN timing analysis in the context of an evolutionary, incremental network development process, which can be found at almost every OEM today. Powerful timing analysis tools are highly valuable and have become standard process components for three key steps: the approval (or rejection) of individual CAN network change requests, the timing verification of a new CAN network release, and the estimation of future extensibility. These are the most commonly found use cases for CAN timing analysis. The last use case becomes relevant when there are no more reserves for changes and a major update of the network architecture is needed.

Sooner or later, the lifecycle of any evolutionary network architecture will come to an end, at the latest when all buses are “full” and any added signal will compromise the real-time behavior and break the communication. In this situation, more fundamental (and revolutionary) changes to the network architecture are needed, beyond message layouts and CAN IDs. Among the most popular of such changes are:

- ◆ Complete redesign and optimization of the bus configuration (signal-to-frame mapping, CAN IDs),
- ◆ Change mapping of functions in order to reduce the communication volume on the bus, then a redesign of the network configuration,
- ◆ Switch from CAN to CAN FD for all or some ECUs,
- ◆ Introduction of several CAN segments, linked/bridged together by existing or new ECUs with two or more CAN connections,
- ◆ Use of parallel buses between ECUs with two CAN connections,
- ◆ Redesign of the entire E/E architecture (and the use of FlexRay and/or Ethernet for high-bandwidth segments or backbone network).

While all strategies gain some headroom, reduce the bus load, and lead to shorter bus message response times, they differ in their collateral consequences such as development time, deployment cost, and signal latencies, which can also increase when for instance gatewaying is added. The actual choice of the strategy for such a major update usually depends on more aspects, not only timing but also strategic, manufacturer-specific decisions. What all manufacturers have in common,

however, is that they must ensure sufficient real-time capabilities of any new network architecture. For this, they can again use the response time analysis tools they already know from other use cases. Vehicle manufacturers usually explore more than one architecture strategy before they make the final decision. And with a systematic timing analysis process in place, they can also evaluate each architecture candidate from a timing perspective. Daimler has presented timing-enriched E/E architecture exploration from the time they introduced Flexray [3]. The Symta/S timing analysis for CAN and Flexray was an integral part of the presented process.

CAN and Ethernet

And what about Ethernet? Ethernet was first introduced as a separate overlay architecture for the bandwidth-demanding video and object recognition functions of ADAS. CAN still plays its role as the protocol of choice for cost-efficient and reliable in-vehicle signal communication for the classical domains. In the future, we will likely see Ethernet links with some backbone functionality, transferring signal PDUs between the CAN domains. Interestingly, this will make the CAN timing more complex, at least for the cross-domain traffic because the CAN-to-Ethernet and Ethernet-to-CAN gateways add delays to the signals that must be considered. Symta/S, as the leading network timing analysis tool for automotive, already supports CAN, Flexray, LIN, Ethernet, and gateway timing analysis.

Author



Dr. Kai Richter
Symtvision GmbH
www.symtvision.com
info@symtvision.com

Related link

[Analyzing the performance of CAN networks](#)

References

- [1] D. Gunnarsson, C. Pigorsch, M. Traub: Timing Evaluation in E/E Architecture Design. ATZ Elektronik 01|2015.
- [2] I. F. Amato, M. Melani: Timing & Distribution Analysis with Symta/S at Fiat Group Automobiles. Fiat Timing Conference, Torino, 2011.
- [3] M. Traub, V. Lauer, T. Weber, M. Jersak, K. Richter, J. Becker: Timing Analysis for Verification of Network Architectures, ATZ Elektronik, 03|2009.

Pioneering new technologies
Pioneering new technologies

STW[®]
30
JAHRE

Sensor-Technik Wiedemann GmbH
Mobil-Steuerungen und Messtechnik

32 bit electronic control unit ESX[®]-3XL



- 32 bit controller with max. 136 I/Os and 4 × CAN
- Freely programmable in „C“ and CODESYS
- Certified for safety applications (SIL2, PLd)
- Including Memory Protection

Pressure transmitter with thin-film measuring element



- Pressure ranges from 0 ... 10 bar to 0 ... 2000 bar (Overall accuracy in the temperature compensated range: 1%)
- Max. media temperature 150°C / max. ambient temperature 125°C
- Wetted parts and case in stainless-steel
- CAN-Bus interface

Exhibitions



bauma Africa, Johannesburg
15.09. – 19.09.2015
Hall 5, Booth C11



Agritechnica, Hanover
08.11. – 14.11.2015
Hall 17, Booth A34

Sensor-Technik Wiedemann GmbH
Am Bärenwald 6 · 87600 Kaufbeuren
Germany
Telephone +49 8341 9505-0

Electronics first – or housing?

Device manufacturers specialize in electronics. Encasing these electronics in housings is usually a job for the team's electromechanical experts. Which point of the process is right for choosing a suitable housing?



Figure 1: ESD deploys a modular housing concept for the production of its electronics devices (Photo: Phoenix Contact)

With its CAN-CBX device range, electronics manufacturer ESD settled on the housings first – the I/O system was only developed once the enclosure was in place. Before the electronics of a new device are developed, some consideration should be given to how they will be housed. For ESD Electronic System Design, this makes sense. The company predominantly develops and manufactures industrial communication modules based on the CAN protocol such as CANopen and Devicenet. The company is a founding member of CiA and a member of ODVA (Open Devicenet Vendors Association).

“With the CBX series, we have a CAN-based I/O system in our product range that is continually updated and expanded,” said ESD Sales Director and CiA Business Director Harm-Peter Krause. “We have numerous gateways for communicating with other networks including Profibus, Profinet, Ethernet, and Ethercat. Further modules are available for integrating devices with serial or wireless interfaces.”

From the housing to the idea

In the development of the CBX modules, the final exterior was conceived right at the beginning. Phoenix Contact's

modular ME MAX electronics housing formed the starting point of the development process. This housing system not only encases the electronics but also provides a special feature that inspired the developers to embrace a new system concept. “The housing system's mounting rail bus connector is perfect for handling communications between the modules,” said Krause. “Our aim was for the five-pin bus

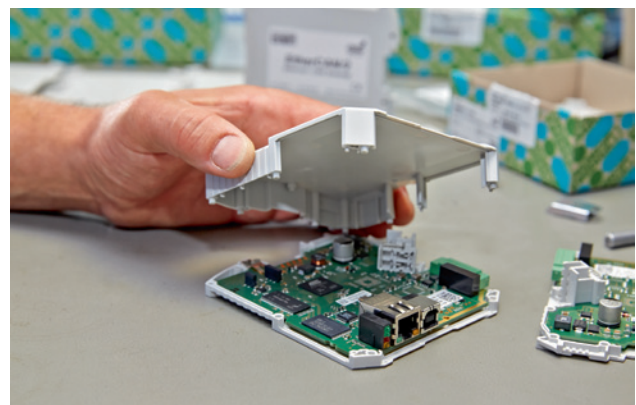

Figure 2: ESD's device manufacturing makes use of the modular electronics housings from Phoenix Contact's ME MAX series (Photo: Phoenix Contact)



Figure 3: Thanks to their versatile contours, insertable cover plates are suitable for individual modifications (Photo: Phoenix Contact)

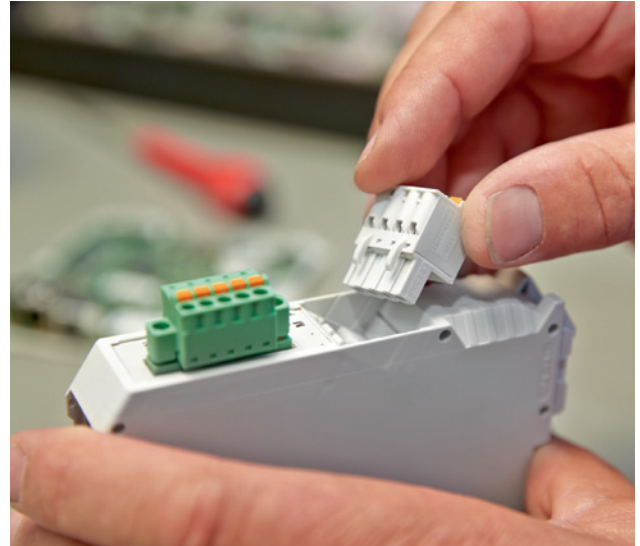

Figure 4: Thanks to push-in plug connectors, the devices can be wired up without any tools (Photo: Phoenix Contact)

connector to carry the two CANopen signals, i.e., the high level and low level signal, as well as the two pins for the 24-V supply voltage and the functional earth ground.”

Communication between the modules takes place inside the mounting rail, which is more accurately known as the in-rail bus. The T-shaped plug connector snaps onto the DIN rail. “This makes installation a lot faster for our customers in terms of wiring costs and effort,” adds Krause,

“and when it comes to maintenance, the modules can be replaced without disrupting the running processes.”

In order to meet the highest safety standards, the contacts of the cross-connector are gold-plated. Once ESD had established its mounting rail-based system concept for the device series, the developers turned to designing the electronics. The outcome of this approach was a device series where all the modules have identical ▶

LIN & CAN Bus simulation for test and production

Event Triggered Frames
Diagnostic Frames
Node Identifiers
Schedule Tables
Signal Groups
Signal Encoding & Representations

Typ: Logischer Wert
Typ: Logischer Wert
Typ: Logischer Wert

LIN protocol >= 2.0 only:
Produkt-ID des Herstellers: 0x40
Funktion: 0x7002
Variante:
Antwortfehler: COMM
P2 min [ms]:
ST min [ms]:
N_As Timeout [ms]:
N_Cr Timeout [ms]:

I/O Digital
RS-232



Figure 5: The control and monitoring system of Menck's deep sea hydraulic breaker is mounted directly on the pile hammer; only a single cable for power and communication is needed (Photo: ESD)

housings – modules with digital or analog inputs and outputs, modules for temperature sensing, and real-time controllers. Because the series can be expanded with additional devices at any time, more and more gateways have been added, facilitating communication via Profibus, Profinet, Ethernet, and Ethercat.

All of the company's planning, production, and testing takes place at its Hannover plant. After the externally-sourced, pre-fitted PCBs are tested and the firmware is installed, they are mounted in their respective housings. First, the functional earth ground is placed in the left half of the housing and the PCB is positioned (Figure 2). The FE contact is established later on when the housing is snapped onto the DIN rail. "This has greatly simplified the handling of the modules for our customers," said Krause.

Next, the right half of the housing is assembled and locked in with the mounting lugs, and the cover plate is inserted (Figure 3). The cover plates vary depending on their labeling and on the openings they provide for the different display and operating elements. While the modules' housings are identical, the cover plates can be matched to each module's specific functions. This includes openings for different connector types, such as signal or data

connectors. The CBX series predominantly makes use of push-in plug connectors (Figure 4). The special contact spring of this design ensures gas-tight contacting and requires high cable withdrawal forces. Rigid or flexible wires with ferrules are also easy to connect due to the low insertion forces required. The last stage of assembly is installing the plug-in connectors, and then the modules are packaged for shipping.

Customer-specific solutions

ESD also develops and manufactures individual customer solutions for sectors such as automotive production, mechanical engineering, medical technology, aviation and aerospace, as well as offshore deployment. The requirements placed on the housings are worked out in close consultation with the customer. Once the requirements profile of the finished solution is in place, the functions of the housing are specified – such as installation space, housing materials, connector types, and environmental conditions. Before the PCB can be planned, a suitable electronics housing needs to be determined.

Initial prototypes usually take four to six months to produce, again in close dialog with the customer. Serial production typically commences after another three months. An example of a customer-specific solution for the aviation industry is an aircraft cabin simulator. "What happens when all of the passengers press the overhead light button at the same time?" asks Krause. "While this most likely will never occur in practice, it still needs to be simulated. After all, the cabin lights should be fully functional at all times."

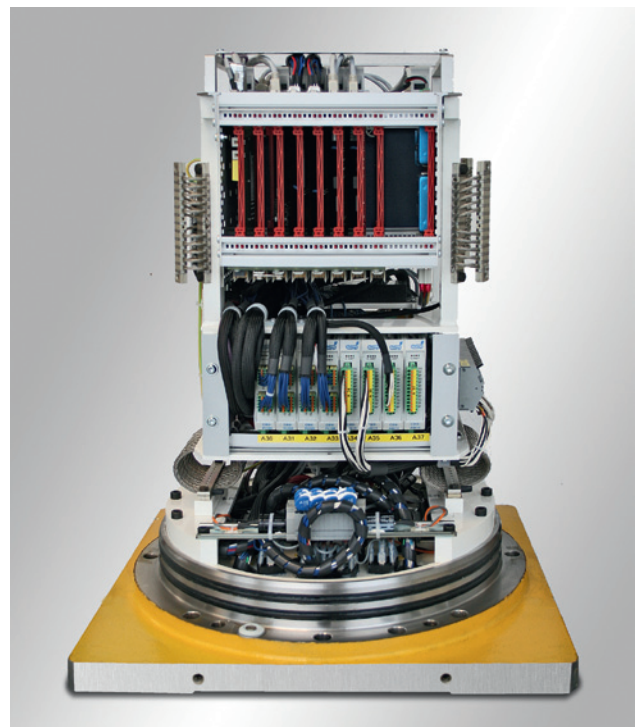

Figure 6: The MUX box is the centerpiece of the control computer – it is based on a Power PC architecture with a Compact PCI system and CAN communications; the I/O modules of the CBX series can be seen in the middle (Photo: ESD)

Deployment in underground hydraulic breakers

One example of one of ESD's many customer-specific solutions is the hydraulic breaker of Menck. The breaker is deployed at depths of 1800 m to 3000 m in the construction of deep sea foundations or for oil drilling. The CAN-CBX I/O series is used on these breakers to increase operational reliability and the control system's functional range. A pressure-tight container is used to protect the control and monitoring components. The container is installed directly on the pile hammer (Figure 5).

Communication between the hammer drill and the on-board PC-based operating computer is handled via the DSL wires of the used single cable. The I/O modules inside the MUX box are deployed together with sensors for tasks such as measuring depth pressure or acceleration (Figure 6). A number of additional Pt100 inputs record various temperatures. These measurement readings, which are displayed by the operating computer, provide information about water penetration, water pressure, oil temperature, and much more.

With Phoenix Contact's ME MAX housing system, ESD has found the right type of enclosure for its I/O system. Its crucial advantage is its mounting rail bus connector, which carries both data and power signals. This eliminates unnecessary cabling and human error during wiring, and simply snapping the modules onto the DIN rail saves a lot of time. Because only a single housing type is being used, this keeps the part variance low, while all the individual functions are accommodated via variable cover plates.



Author

Marta Ciesielski
Phoenix Contact GmbH & Co. KG
www.phoenixcontact.com
corporatewebsite@phoenixcontact.com

Related link

[Not only partner of the medical industry](#)

One card, many possibilities



With
CAN FD
support

IXXAT CAN-IB-Series

- Modular PCIe cards with up to four CAN (HS/LS), CAN FD, LIN and K-Line Interfaces
- As standard, low-profile, mini PCIe and PCIe104 version
- Easily expandable with customer specific piggyback modules
- Drivers (32/64 bit) for Windows XP, Windows7/8, Linux, QNX, INtime, VxWorks and RTX



New

CAN-IB300/PCI CAN-IB400/PCI

- CAN-IB-Series extended by cost-effective PCI cards
- Available as passive or active (32 bit μ C) version enabling intelligent handling and active filtering of messages
- Up to four CAN interfaces (optional low-speed CAN and LIN)

HMS Industrial Networks GmbH
Emmy-Noether-Str. 17 · 76131 Karlsruhe

+49 721 989777-000 · info@hms-networks.de
www.anybus.com · www.ixxat.com · www.netbiter.com



Optimized run time behavior

Profiling in software technology means that information is processed, which helps analyze the specific execution time of application POU's. For this purpose, the Codesys Profiler is provided as an add-on component.

After being installed in the Codesys Development System, the Codesys Profiler automatically measures single tasks of IEC 61131-3 automation projects. The measuring results allow users to optimize the runtime behavior and thus the quality of their control applications. The Codesys Profiler is part of the Codesys Professional Developer Edition since May 2015.

These days, manufacturers in the automation industry supply hardware of different performance levels. Users of these hardware devices work with tools like the Codesys Development System to develop the necessary control programs in the languages of IEC 61131-3. The processing power of the hardware has become more and more exhausted in this process. If users realize that their application code is reaching the performance limits of their controller, they can optimize the application code before taking the software into operation. Thanks to methodical support, the data necessary for the optimization process can be determined without additional hardware or application software. For example, the runtime of the CANopen Safety Stack can be measured and taken into consideration.

The task configuration of the Codesys Development System already provides information on the (maximum) cycle time of the used tasks. The Codesys Profiler is an optional add-on tool and supplies application developers with detailed runtime data of the control program on POU level. In order to identify these data, the activated add-on generates additional machine code wherever there is a function input or output when compiling the IEC 61131-3

application code. This machine code is transferred to the target system along with the application code and then executed. In contrast to a manual procedure, a measurement of all POU's is automatically ensured, thus minimizing the time needed for runtime measurement. Looking at the data gathered, application developers can easily identify which POU's are most relevant to the total running time of the application and consequently make modifications to optimize time behavior.

During code runtime, the measurement results can be demanded, loaded, and displayed directly in the development environment at the user's discretion. As illustrated in the picture, different views allow the user to choose different perspectives to analyze the situation. POU's passing the pre-defined threshold value, limiting their share of the total running time of the application, are marked in a different color. Thus, users can identify POU's with a particularly long running time. Most helpful information is provided by the display of the call frequency of POU's, as these data allow for the user to determine the relevance of a certain POU for the total running time.

After finishing the runtime analysis, the Codesys Profiler can be deactivated with a mouse click. The optimized application code is then loaded onto the target system. Whereas manual measurement leaves some residue in the final code, this is not the case when using the Codesys Profiler. When comparing historical with current values, all results should be stored in the runtime analysis. By regularly evaluating these results, the efficiency behavior of the application is displayed over the whole development period. In this way, problems are revealed at an early stage, thus putting the user in a position to estimate whether the projected task execution times can be accomplished.

Using tools which provide methodical development support improves the quality of IEC 61131-3 applications in automation technology and at the same time reduces the necessary effort. The Codesys Profiler for runtime analysis helps users identify and prevent potential

problems are revealed at an early stage, thus putting the user in a position to estimate whether the projected task execution times can be accomplished.

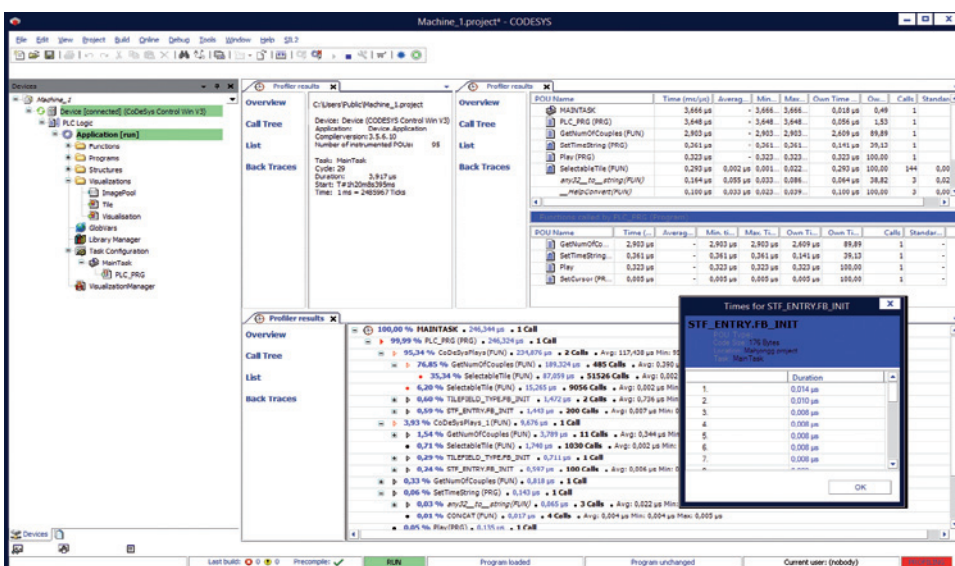

Figure 1: Integrated profiling results with helpful information (Photo: Codesys)

problems caused by controller overload. It can be purchased in the Codesys Store and can be directly installed in the Codesys Development System. With the available trial version, users can test the product before use.



Author

Michael Schwarz
3S-Smart Software Solutions GmbH
www.codesys.com

Access to CANopen via IEC 61131-3 devices

The CiA SIG (special interest group) Application Layer is currently finalizing the CiA 314 specification. Usage of this document allows standardized access to CANopen services from devices programmable in IEC 61131-3 languages. Such devices may be PLCs (programmable logic controllers), PC-based controllers, HMIs (human machine interfaces), etc.

The document specifies function blocks to produce or consume CANopen communication services and to provide local CANopen functions. These include, among others, SDO (service data object) read/write access, NMT (network management) control, emergency message handling, as well as the creation of object dictionary entries. The available CANopen functions are based on CiA 301 v. 4.2, which has no relation to CAN FD (CAN with flexible data rate).

CiA 314 derives from the withdrawn CiA 405 document, which provided a different addressing scheme. The new addressing is as follows: All CANopen communication stacks in a system have a unique number (kernel-ID). A kernel operates on one CANopen interface port (interface-ID). Specific CANopen devices in the network are still addressed via their node-ID. In the system, a mapping table exists, which assigns kernels to interfaces. Thus, the kernel-ID implicitly specifies on which physical CANopen interface port the communication is running and the interface-ID is not used for addressing. The benefit of this addressing is that a kernel may later be moved to a different interface port without changing the available application code. The kernel-ID stays the same. This makes the hardware addressing transparent to the user.

To simplify the specification use in different systems, some platform-dependent parameters, e.g. time stamp and pointers to data, are left for the user to define. The timeout function (maximum allowed execution time) is also included into the function blocks.

The CiA 314 specification substitutes a part of the CiA 405 document, whose content was also partly moved to CiA 302-4 (network variables and process image) and CiA 306-3 (network variable handling and tool integration). The application note CiA 809, which is currently under development, provides an implementation and a user guideline for IEC 61131-3 devices.

Olga Fischer (CAN in Automation)

**canAnalyser
New Version 3**

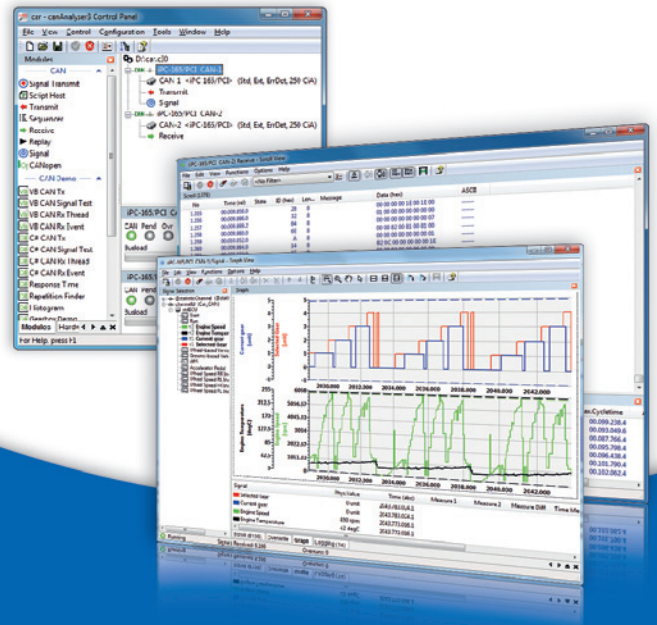

- Powerful analyzing, stimulation, recording and data interpretation functionality
- For CAN, CANopen, DeviceNet and SAE J1939 based systems
- New: Multi-board feature supports multiple CAN interfaces simultaneous
- New: Improved database concept and graphic display of signals and statistic data
- New: Data transmission and reception based on signal level



Also in combination with the new

USB-to-CAN V2

- For mobile analysis and configuration of CAN systems as well as for sophisticated simulation and control applications
- Up to two CAN interfaces (optional low-speed CAN and LIN)
- USB 2.0 Hi-Speed: Minimal latency and high data throughput

HMS Industrial Networks GmbH
Emmy-Noether-Str. 17 · 76131 Karlsruhe



+49 721 989777-000 · info@hms-networks.de
www.anybus.com · www.ixxat.com · www.netbiter.com

Filtration process for improved drinks

TMCI Padovan, an Italian food and beverage processing equipment manufacturer, uses distributed drives from Nord Drivesystems in its Dynamos rotating dynamic cross-flow filter systems.

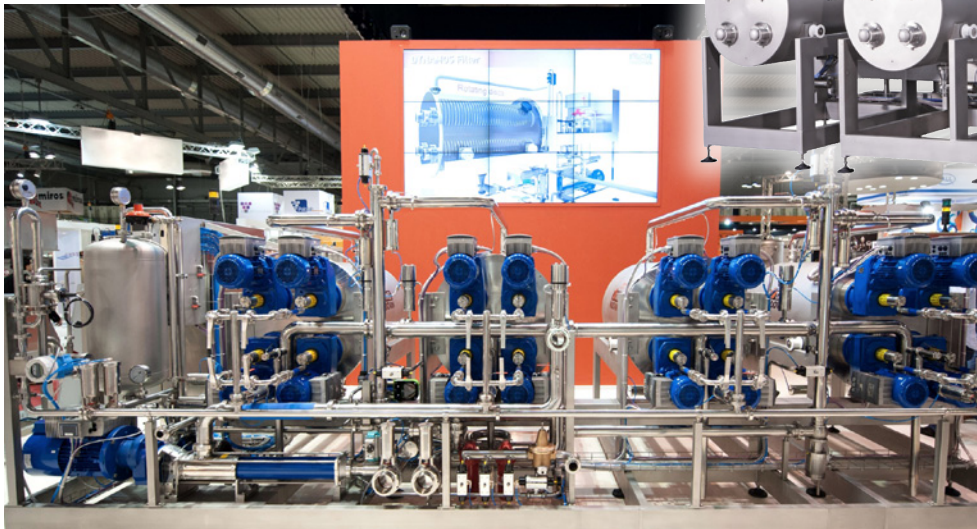

Figure 1: TMCI Padovan's Dynamos systems employ a gentle filtration method for musts: geared motors with integrated inverters from Nord Drivesystems perform various drive tasks (Photo: TMCI Padovan)

The Dynamos rotating dynamic cross-flow filter systems feature a calibrated back-pulse system and a new filtration method for the wine and juice industries that allows a low-energy, low-labor, and continuous system for turning press wine or fruit juices into clear liquids with optimal results. The method does not require the use of filtration aids.

TMCI Padovan's customer, a well know Italian producer of vermouth fortified wines, required a solution to replace a traditional vacuum filter which typically has a low cycle cleaning requirement that hindered the processes they wanted to perfect. Due to the large volumes processed, a reliable and low-energy machine was required to operate every day of the year for eight to ten hours on average. The Dynamos filter was identified as a possible solution to the problem, and the customer asked TMCI Padovan to perform a test in its production plant.

Equipped with mechatronic drive units from Nord, Dynamos offers advantages that were decisive for the final choice. Firstly, the software flexibility allowed the customer to consistently match the operating parameters to create its final product quality. Secondly, the compactness and the cleanliness in operation: the cross-flow filtration allows hygienic operation in a closed system that reduces the overall plant size.

The operation without filtration aids and modifiers benefits product quality and the environment, with the additional advantage of reduced waste. Moreover, during filtration the energy consumption is decreased compared to conventional models, the temperature rise is negligible, and the closed system means that product oxidation is close to zero – all important factors for making great tasting wines and juices.

Proven rotary cross-flow filter

TMCI Padovan's Dynamos is the first rotating dynamic cross-flow filter with a calibrated back-pulse system for evacuating the filtrate. This design has been hailed as the most valid technology for the filtration of must and wine grounds – and other liquids that have a high level of suspended solids – without filter aids or modifying agents.

The 'rotation dynamic' cross-flow filtration system consists of a sealed chamber fed by a peristaltic pump and a series of spinning porous ceramic disks. Spinning membranes are responsible for the filtration, not a forced liquid flow as is usual for conventional cross-flow filtration systems. This low energy consumption process prevents lock-ups and allows easy cleaning. It enables long filtration cycles of up to 72 hours without interruptions with high flow rates between 25 l/m²h to 50 l/m²h with lees. The available models are compact, easy to operate, and are supplied with filtration membranes with a total surface area between 1 m² and 80 m² and multiples.

The filtered product can be bottled directly as is the norm with traditional cross-flow filters but the absence of red color reduction and the low oxygen absorption make the process especially interesting to the industry – so much so that Dynamos received the prestigious Innovation Award when the system was shown at the SIMEI 2011 fair in Milan, Italy, and the "Palmarès de l'Innovation" at the 2013 SITEVI show in Montpellier, France. ▶

CAN FOR EXTREME ENVIRONMENTS

CANopen Coupler D-Sub /XTR, 750-338/040-000

CANopen®

XTR



750-338/040-000



750-8204



750-337, -837



750-337/040-000
750-837/040-000



750-338



750-347



750-348



767-1501



767-658 (CAN)

The WAGO-I/O-SYSTEM 750 XTR – TAKING IT TO THE EXTREME

- eXTReme temperature ... from -40°C to +70°C
- eXTReme vibration ... up to 5g acceleration
- eXTReme isolation ... up to 5 kV impulse voltage
- eXTReme dimensions ... as compact as 750 Series standard

www.wago.com

**WE
INNOVATE!**

WAGO®



Figure 2: The TMCI Padovan Group is the reference technological partner for the wine industry and, more generally, for the food and beverage industry (Photo: TMCI Padovan)

Various drive tasks

Thanks to certain technologies, this system can be competitively developed and produced. These technologies include the Nord Drivesystems technologies that are used in Dynamos filter systems. Depending on the size, each model contains several parallel shaft-gearred motors. As these rotate the filtration disks, their number varies as a function of the number of disk-holding shafts – one machine can hold one to 16 shafts. Additionally, the machines have one or two tanks for the produce, and each tank has four drives. Each drive includes a motor-mounted decentralized SK 200E frequency inverter. The sensor-less inverters ensure tight speed control and maintain the high-quality process without the need for sensor feedback. The drive speed is adjusted through the machine's PLC via fieldbus communications. Finally, a separate distributed Nord motor drives the circulation pump.

SK 200E distributed inverters are available as models either for installation close to the motor or integrated in the motor. They feature the equivalent function range of the SK 500E centralized inverter series for cabinet installation. In addition to offering an overload capacity of 200 %, the distributed inverters can be placed close to the application for compact and efficient operation with less wiring than conventional panel-mount solutions. Relative or absolute positional values can be controlled by binary values from the PLC entered through SK 200E inputs and stored in the drive. As an alternative, they can be set through a choice of fieldbus systems. Position feedback can be provided through incremental encoders with the standard level of supply including an on-board reference function for this purpose, or it is possible to directly set positional values with an absolute encoder via CANopen. For all these alternative control options, configuration requires only few parameters for commissioning and optimization.

Various features of Nord products contributed to the successful implementation of the filtration machines. The rotation accuracy directly influences the quality of the overall performance of the system. The energy-saving function adjusts consumption to a fraction of the rated power during partial-load operation. Their compactness makes mounting the distributed drives particularly easy. The local storage of all the programming data on removable EEPROM facilitates commissioning. And lastly, the optional matching of safety standards such as EN 61508: SIL3 was fundamental to the application.

Furthermore, the possibility to communicate with the PLC through the fieldbus specified by the customer, using a single node for multiple users, resulted in cost savings by allowing the interfacing of the drives with the CANopen-based fieldbus that is a standard feature of Nord inverters. A smaller-sized main control cabinet and simplified machine commissioning resulting from the use of decentralized geared motors and separate motors, saved further costs.

Other features include the configuration options that are available through the SK 200E series. The customer was able to make use of simple solutions for addressing the distributed nodes and benefitted from the status LEDs and the diagnostics that can be read via EIA-232 both on inverters and on distributed nodes through the Nord CON PC software for controlling, parameterization, and diagnostics of all Nord frequency inverters.

Nord supported the customer in the selection and commissioning phases of the machines. "We selected Nord because of the quality and the robustness as well as the build construction that we consider to be suitable for prolonged industrial use", said Narciso Gatti, Purchase and Operations Manager of TMCI Padovan. "Our company already used Nord drive technology, especially for vacuum filters, vegetable oil processing machines, and tunnel pasteurizers. Nord Drivesystems has been supplying TMCI Padovan for a long time, ever since we first made contact more than ten years ago." Nord mechatronic drive units replaced belt driven transmissions that the company had used in previous filters. "The new technology allowed us to obtain several advantages, like a greater energy saving, a greater reliability, a more simplified machine design and much increased safety for operators," added Gatti. ◀



Author

Jörg Niermann
Nord Drivesystems
www.nord.com
info@nord.com

International trade magazine
for the technology of elevators
and escalators

 lift
report

PLEASE
CONTACT
US TO GET
A SPECIMEN
COPY!

**Lift-Report takes part regularly in all major
fairs and trade events – worldwide.**

**Take the advantage of the magazine and make
new contacts in the lift industry.**



Hengsener Straße 14 . 44309 Dortmund . Germany
Phone: +49(0)231/92505550 . lift@vfz-verlag.de
www.lift-report.de

Connecting automotive standards

Pressure of time and cost and faster development processes require flexible automotive measurement systems. They must be able to be adjusted to different measurement applications in a short period of time.

The Ipetronik system bus X-Link provides a measurement system, which connects automobile standards such as Ethernet, CAN, IEEE 1588, or XCP. With this combination of technologies, a decentralized and automotive measurement system is available for the user. The system grows continuously with new technologies available on the market, without neglecting already existing measurement modules.

The X-Link technology stands for the synchronous connection of Ethernet measurement technology with CAN network measurement technology via only one bus to the Ethernet interface of the PC. Ipetronik's scalable hardware solution covers all areas of decentralized measurement technology in combination with Ipemotion as a complete solution software. It also covers the connection to existing engine application systems, for example Inca or A2L. For parameterization of the system, configuration via Ipemotion is supported, as well as via add-ons (currently Ipeaddon Inca 5 for Etas Inca). The user is able to analyze measurement data of different applications either with Ipemotion or with the analysis packages and software tools Vector CANape, NI Labview, AVL, ATI Vision, and Etas Inca. Besides the CAN network measurement technology for physical values such as pressure, temperature, voltage, and flow rate (up to 1 kHz), there is also an increased need for additional faster measurement channels up to 40 kHz/channel: for example, to optimize injection behavior or to perform parallel to standard signals, or vibration, oscillation, and acoustic measurements – always with the objective of reducing further test phases.

The time synchronization of all signals, as well as a familiar software interface, avoids additional offline editing of signals and time-consuming setup and adjustment phases. Thus, the user's proved and familiar workflow remains, so that fast and flexible work is possible. Existing bus systems have limitations, for example limited channel sampling rates, fewer configuration opportunities for individual devices or limited signal bandwidth since the system is always running at the highest signal sampling rate. Customers would often like to use existing approved measurement devices together with new Ethernet devices in the same new system. With the X-Link technology, a measurement system is available for users, which connects standards and thus ensures a symbiosis of two bus systems and therefore an optimal workflow.

With this link of standards, a hardware platform is provided which is able to currently run at a sampling rate up to 40 kHz due to the used software application. At the same time, the already existing Ipetronik CAN network

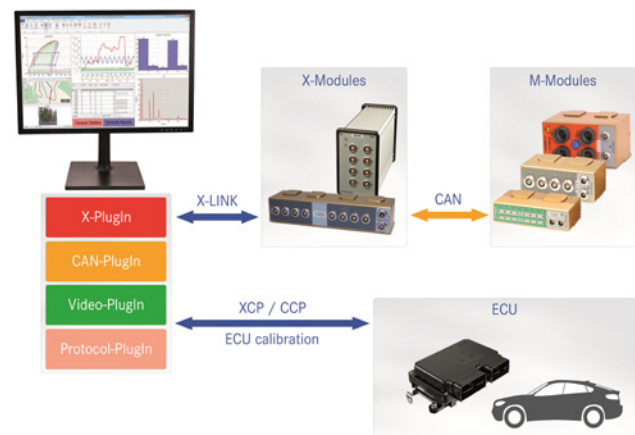

Figure 1: Application example of X-Link technology with Ipemotion (Photo: Ipetronik)

measurement technology can be used in the system time synchronously.

Flexibility as a basic condition

For usage in already existing systems or as a basis for new systems, at least some of the following requirements should be ensured:

Software Ipemotion: One software for the entire measurement chain – starting with the configuration of the systems (plugins), the acquisition of measuring data and monitoring, to a comfortable analysis; or starting with data export to external applications, Ipemotion is also suitable for application specific usages, such as climate data analysis with log p/H. diagrams or component and durability analysis.

Software Inca – Ipeaddon Inca 5.0: Existing and proved software tools, which partly include extensive analysis routines and processes, are continuously supported. The user can continue to focus on common and proved tools, which allow the time synchronous operation and adjustment of control units. Furthermore, the time synchronous access via Etas ES593 on ETK as well as direct tunneling are possible. Besides, due to the tunneling of CAN modules, an ES593 CAN interface remains available for the data acquisition from a CAN network.

Control unit application software: Due to the support of the standard XCP-on-Ethernet protocol, the X-Link system provides the opportunity to measure data directly by using a standard A2L file. With this application, the same workflow as well as the same tools which are used for programming control units can be used. The measurement system

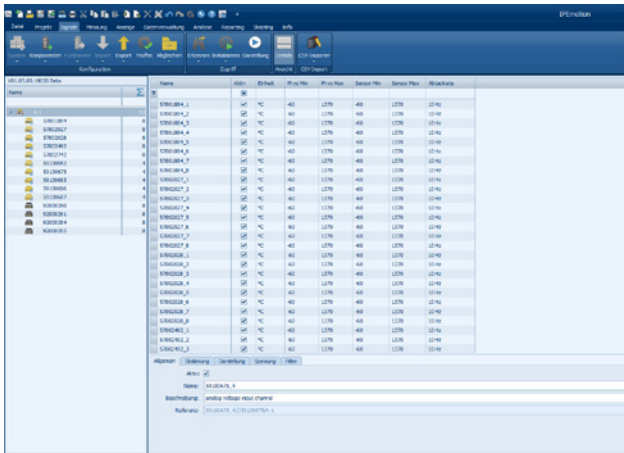

Figure 2: Configuration with Ipemotion (Photo: Ipetronik)

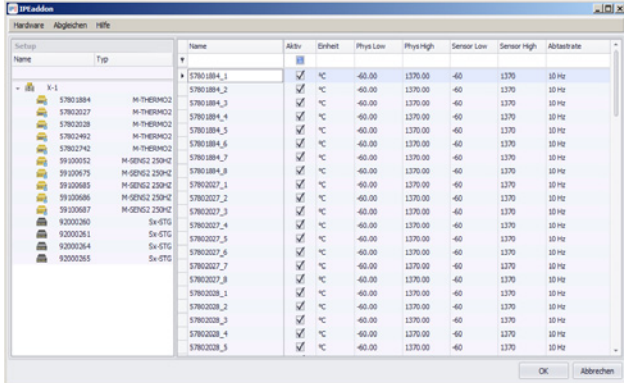

Figure 3: Configuration with Inca (Photo: Ipetronik)

behaves like any other control unit on familiar software platforms with the option of A2L measurement.

Investment security: There is a high investment security. This is not only due to the CAN network basis of the measurement system, or the easy connection to new hardware as well as usage of the X Plugin, add-ons, or their usage via A2L. The system is also continuously maintained and developed by the supplier.

Standards are the basis for X-Link – not a proprietary system, but the intelligent connection of longtime proved standards in the automotive industry, on which the X-Link system solution consequently has been set up.

CAN: The serial network has not only asserted itself because of its high interference resistance, low costs, and real-time capability. All components are connected to the bus system via short stub cables on a mutual data cable, whereby harness and wiring efforts are reduced. The serial bus system, which has been established as a standard in the automotive sector for decades and thus is available in many places, does not need any special drivers. While a standardized description via CANdb is possible, a direct connection of CAN network modules to all familiar measurement software packages or to a test bench is possible, too.

Ethernet: The vendor-independent network technology enjoys a high acceptance on the market and is also used in the automotive sector. Ethernet has approximately a 50-times higher performance than CAN. Additionally, protocols such as TCP/IP, FTP, HTTP, DHCP, WLAN, as well ▶

CAN Products for your requirements



CAN-Repeater CRep DS 102



CAN-LWL-Router CG FL



CAN-Repeater CRep S8C

- Repeaters for different network topologies
- Stub line connection of networks segments
- Optical fibre connection of copper networks
- Cascadable star wiring for up to 24 CAN channels with star repeaters

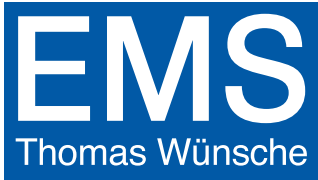

Sonnenhang 3
 D-85304 Immünster
 Tel.: +49-8441-49 02 60
 Fax: +49-8441-8 18 60
 www.ems-wuensche.com

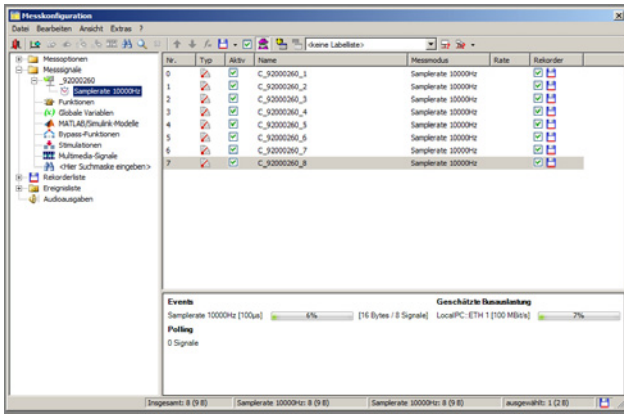

Figure 4: Configuration with Vector CANape (A2L files) (Photo: Ipetronik)

as an Internet connection are available for the technology by default, so that a fast data exchange between locally connected devices is possible. For Ethernet, no additional hardware for the PC or notebook is necessary. Daisy chaining is possible without limits as well.

IEEE 1588: Using the precision time protocol (PTP) defined in IEEE 1588, it is possible to synchronize distributed system clocks to a precision of approximately 1 μ s via the decentralized system. This is enormously important, especially in decentralized distributed systems. The multi-platform driver (PTP driver) developed by Ipetronik provides a universal basis for different software platforms.

XCP: Since its standardization through Asam in 2003, the XCP protocol has been widely distributed during the last ten years for the communication of control units in the automotive industry. As a universal measurement and calibration protocol, it is completely separated from the physical transport layer. Therefore, it is possible to use CAN, Ethernet, or Flexray buses as a transport layer according to required data rates. The XCP protocol provides opportunities for the control of unit applications (measuring, adjusting, flashing). By using the protocol in measurement systems, the system behaves like a control unit: The measuring data is collected as standardized data packages with A2L files via DAQ lists (data acquisition lists), which are automatically created in the Ipemotion software according to the measurement system configuration. A simple and universal connection to all packages of the control unit and application software is therefore ensured.



Figure 5: Application example of X-Link technology with control unit ES593 (Photo: Ipetronik)

Software connection

Due to the multi-platform driver developed by Ipetronik, for the configuration and analysis of measuring data the Ipeaddon Inca 5 is available besides Ipemotion and the X Plugin. Through the universal concept of the driver, more third party software applications are possible, which can be equipped with the same functionality and performance. With the multi-platform driver, the limits of standard XCP protocols (max. 10 kHz/channel) can be avoided (see Table 1).

Table 1: Current possible sampling rates per channel in different software applications

Sampling rate/channel	Ipemotion	Inca	CANape (DAIO)	Diadem (DAC XCP driver)	Test bench/ SW (with SG-interface)
X Plugin	40 kHz				
Ipeaddon Inca 5		40 kHz			
A2L	10 kHz	10 kHz	10 kHz	10 kHz	10 kHz
CANdb	2 kHz	2 kHz	2 kHz	2 kHz	2 kHz

■ Ipetronik multi-platform driver ■ XCP standard (XCP-on-Ethernet)

Table 2: Overview of CAN and X modules

Application	Driver	CAN Modules										X-Bus Modules		
		M-THERMO	μ -THERMO	M-RTD	M-SENS	M-CNT	MultIDAQ	High Voltage Iso DAQ	M-Thermo2 HV	SIM-STG	CANpressure	Sx-STG	Mx-SENS	
IPEmotion	IPE multi-platform driver (PTP)	●	●	●	●	●	●	●	●	●	●	●	●	●
INCA 7.1	IPE Addon INCA 5	●	●	●	●	●	●	●	●	●	●	●	●	●
Description file	A2L													
CANape	Vector DAIO driver											●	●	
DIAdem	NI-Ethernet driver											●	●	
INCA < 7.1												●	●	
Description file	CANdb													
CANape		●	●	●	●	●	●	●	●	●	●	●	X	X
DIAdem		●	●	●	●	●	●	●	●	●	●	●	X	X
INCA < 7.1		●	●	●	●	●	●	●	●	●	●	●	X	X

In future: X = X devices in CAN mode

Application with ES593 interface module

The widely used ES593 interface module from Etas, which is usually used for control unit applications, serves the standard ETK interface of the control unit. Parallel to that, different physically measured values are acquired time synchronously. Inca is used as an application software. With the assistance of Ipeaddon Inca 5, such a system can be realized fast and efficiently. The entire Ipetronik measuring chain can be configured in Inca and appears in the work area of Inca as additional measurement systems. Due to the CAN tunneling of CAN modules via Ethernet, another CAN input on ES593 for vehicle CAN data is available to the user. Thanks to the system concept, high voltage modules by Ipetronik are able to cover characteristics of hybrid and e-drive technology.

Figure 6: Mx-SENS2 with eight analog measurement inputs (Photo: Ipetronik)



The system offers a combination of possibilities, which no other system on the market provides. These are, amongst others:

- ◆ A fully suitable automotive system solution,
- ◆ A consistent toolchain for X and CAN measurement technology from configuration to analysis or reporting,
- ◆ Integration of modules in existing software applications (Inca working area, Diadem circuit diagrams, etc.),
- ◆ Different migration paths according to applications: the X module can be used to expand an existing CAN system or to cover higher sampling rates in future, without buying another system,
- ◆ CAN monitoring: X devices dispose of the need for monitoring, for example for test bench applications. Additional setup times become unnecessary because measuring data can be visualized parallel with a standard CAN interface on the test bench,
- ◆ The software connection via the Ipetronik multi-platform driver or via standard description files A2L and CANdb is also flexible.

Currently, the [Mx-Sens2](#) as well as Sx-STG with sampling rates of up to 40 kHz/channel are available in the Ipetronik X device family. Due to the future-oriented concept, next development steps will make considerably

higher sampling rates possible. The self-developed multi-platform driver provides the software driver basis to use high sampling rates in all software packages (for which a driver is available). Thanks to the standardized Ethernet interface, the system is usable with a PC, notebook, or test bench and in future also with Ipetronik logger platforms. The combination of a proved and existing measuring technology with the newest technologies is future oriented and a directional development for user requirements. Users can decide to buy new measurement technology or integrate it in the existing system: either way, the X-Link technology creates a basis for flexible and efficient measurement.



Figure 7: Measurement module Sx-STG with sampling rates of up to 40 kHz/channel (Photo: Ipetronik)

Author

Harry Störzer
Ipetronik GmbH & Co. KG
www.ipetronik.com
info@ipetronik.com



CAN Products for your requirements



CTrans OL



EtherCAN CI-ARM9

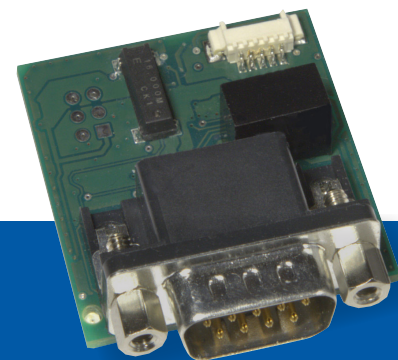

CPC-USB/embedded

- Economical solutions for series applications
- Optimized for industrial applications
- Solutions for stationary and mobile use
- Software support for bus-analysis, measurement and control

EMS
Thomas Wünsche

Sonnenhang 3
D-85304 Ilmmünster
Tel.: +49-8441-49 02 60
Fax: +49-8441-8 18 60
www.ems-wuensche.com

Developments in China increase

The leading German automotive suppliers prepare to move developments to China. This opens up opportunities for CAN interface and tool vendors in the Far East.



German Tier 1 supply produce and develop ECUs in China (Photo: Continental)

Since 2009, China has been the largest producer of passenger cars. Most of the vehicles are assembled by joint ventures and foreign carmakers (e.g. Volkswagen, General Motors, Hyundai, Nissan, Honda, and Toyota). But China has also local brands: Beijing Automotive Group, Brilliance Automotive, BYD, Dongfeng Motor, FAW Group, SAIC Motor, Chana, Geely, Chery, Jianghuai, Great Wall, and Guangzhou Automobile. Most of them are unknown in Europe and North America. In 2014, about 20 million passenger cars were produced in China plus about 4 million commercial vehicles.

Of course, most of the cars produced in China use CAN-based in-vehicle networks connecting ECUs that were mainly developed abroad. But this will change. Market-leading suppliers have already started to develop ECUs with CAN connectivity in China. In particular, Bosch, Continental, and ZF Friedrichshafen have announced additional investments for the next years in production facilities, but also in development projects at the Auto Shanghai 2015 exhibition.

This opens the doors for suppliers of the automotive Tier 1s. Especially CAN interface boards including development environments are needed. Of course, CAN chip-makers will also benefit from this trend as well as CAN toolmakers. The increasing demand for CAN products and tools also fosters local sub-suppliers. CiA member ZLG has developed its own CANscope bus analyzing tool and provides its own oscilloscope with CAN message interpretation software. During CiA's seminar tour in China, the company headquartered in Guangzhou presented the first CAN FD interpreter for its oscilloscope. In addition, the company offers a broad range of USB dongles and other CAN interface modules.

Increasing sales in China

Bosch reported a consolidated sales of €6,4 billion in China in 2014. Peter Tyroller, responsible for Bosch's Asia Pacific business, said: "We want to actively shape the development of the Chinese market, and take advantage

of the wealth of opportunities arising all from connectivity, automation, and electrification, as well as energy efficiency.” To further expand local manufacturing operations and build up research and development in China, the German company has invested 920 million euros over the past three years. In 2014 alone, the investment amounted to almost €330 million.

Bosch Software Innovations launched a pilot project for promoting electric vehicle application in Shanghai in 2013. Automated driving is an example of the potential and advantages of connectivity technologies. With connectivity-capable devices such as sensors, cameras, and electronic control units, Bosch can offer driving assistance functions that will lead to automated driving in the future. Of course, CAN and CAN FD connectivity plays an important role in this application.

Continental, another German automotive supplier, opened a research and development center for tires in He-fei at the end of March. The center is equipped with state-of-the-art test systems. At the Auto Shanghai event, the company presented various customized solutions and products for the Chinese automobile market. Dr. Ralf Cramer, CEO of Continental China, said: “Our drive in China is to invent, develop, produce, and market indispensable, customized technological solutions that shape the five mega trends of mobility in China.” This includes buses and metros, but also commuter and high-speed trains. The company develops dedicated CAN-based products for the Chinese market, especially for e-mobility.

Market researchers expect a big future for e-mobility in China. The success of battery-powered two-wheelers with annual sales figures of about 20 million units is one of the background reasons for this optimism. However, the e-car business is still very small, not just because of the poor infrastructure of charging stations. Foreign cars with combustion engines are still the most popular. If affordable, Chinese people like to buy medium vehicles or even luxury cars, which have the highest growth rate.

Nevertheless, Continental China develops and produces a broader and more efficient range of diversified solutions. Passive Start and Entry Systems (PASE) for a comfortable and convenient hands-free access have been in high demand for many years. Continental has also developed electronic brake systems for scooters and motorcycles of all classes based on its tried-and-tested passenger car ABS technology. The daughter company ContiTech has developed a drive system, which uses belt technology instead of conventional chains on pedelecs and e-bikes. According to the company, this offers a lighter, cleaner, and more powerful pedaling experience.

The third German Tier 1, ZF Friedrichshafen, active in China, has recently acquired TRW Automotive, which doubles the sales in China. ZF China reported a 15-% sales increase for 2014, not considering the acquisition. The company has operated in China for more than 30 years. About 700 engineers are focused on development in its Chinese headquarters. The company invests more than 5 % of its sales in research and development each year. For this year, additional investments in the R&D laboratories and test benches in Shanghai are planned. “We will then be able to test products of car driveline and chassis

Chinese car brands

The Chinese automotive industry is more than half a century old: the first plants were founded as early as the 1950s, assisted by the USSR. They had small manufacturing capabilities, geared to produce not more than 100 000 to 200 000 cars per year. However, since the 1990s, China has invested a lot of money into the development of the national automotive industry, which paid off quickly: by 1992 the number of cars produced in China exceeded one million units.

While in 2003 China was the fourth largest world automobile producer behind Japan, USA, and Germany, by 2008 it had become the world’s leading country in terms of vehicles production and sales. In 2014, China manufactured 19,91 million cars, with a significant percentage being local brands. The better part of the cars produced by the Chinese car companies remains in the country. Chinese business class automobiles appear to be the most popular items of automotive exports: most of them are sold to emerging economies.

technology as well as commercial vehicle or constructions machinery transmissions,” said Stefan Sommer, CEO of ZF, according to China Daily.

ZF China supplies foreign carmakers as well as local brands such as BAIC, FAW, Great Wall, and SAIC. The business with Chinese automakers already makes up about 30 % of the company’s turnover. As the Chinese government requests lower energy consumption and reduction of pollution, ZF China is developing electric-powered cars in close cooperation with its local partners. In the past 20 years, the company has established 20 production locations in China.

Many of the supplied products provide CAN connectivity. This includes the AS Tronic automatic transmission for commercial vehicles. One million of those units have been produced since 1997. In 2010, the product received a Chinese innovation award. And the next generation of automatic transmissions has already been developed: The Traxon modular system will gradually replace the AS Tronic over the next few years. It is suitable for torque requirements of up to 3500 Nm and can be linked to five modules such as the GPS Prevision. This gives truck makers the opportunity to link the transmission with GPS data and digital map material. In this way, unnecessary gearshifts can be avoided – for example when a conventional transmission control unit would shift up a gear at an uphill gradient or a narrow bend, just to shift down to a lower gear shortly after.

The increasing development and production of automotive electronics by German suppliers requires dedicated CAN interface boards for evaluation and test purposes. Those products and the related software tools today use the Classical CAN data link layer and will use CAN FD tomorrow. Etas, a Bosch daughter, already promoted CAN FD connectivity during the last CiA seminar tour in several Chinese cities. Kvaser, which is headquartered in Sweden, has done the same.

Holger Zeltwanger

Rise of the service robots

The market for service robotics is growing. Service robots have been employed in industrial settings for many years, with a steep increase in recent years. Service robots for domestic use are still under development, but they are catching up.

According to figures provided by the International Federation of Robotics (IFR) around 21 000 service robots were sold for professional applications in 2013, generating sales of \$3,6 billion. Since 1998, a total of about 150 000 service robots for professional use have been counted. Because of the diversity of these products resulting in varying utilization times it is not possible to estimate how many of these robots are still in operation. Some robots (e.g. underwater robots) might be in operation for more than 10 years, compared to an average of 12 years in industrial robotics. Others, like defense robots, may only serve for a short time.

It is interesting to note that up to 2008 about 63 500 service robots for professional use were sold during a period of more than 12 years. However, during the past five years, some 100 000 service robots for professional use were sold. This demonstrates the accelerating rate of increase in sales. Still, few main application areas make up most of the volume: Service robots in defense applications accounted for almost 45 % of the total number of service robots for professional use sold in 2013.

Almost 5100 [milking robots](#) were sold in 2013 compared to 4750 units in 2012, representing a 6 % increase. 760 units of other robots for livestock farming such as mobile barn cleaners or robotic fencers for automated grazing control were sold in 2013, resulting in an increase of 46 %. The total number of field robots sold in 2013 was about 5900 units, accounting for a share of 28 % of the total unit supply of professional service robots.

Sales of medical robots decreased by 2 % compared to 2012 to almost 1300 units in 2013, accounting for a share of 6 % of the total unit sales of professional service robots. The most important applications are robot assisted surgery and therapy with more than 1000 units sold in 2013. Medical robots are the most valuable service robots with an average unit price of about \$1,5 million, including accessories and services. Therefore, suppliers of medical robots also provide leasing contracts for their robots.

About 1900 logistic systems were installed in 2013, 37 % more than in 2012, accounting for 9 % of the total sales of professional service robots. Medical robots as well as logistic systems are well established service robots with a considerable growth potential.

In 2013, about 4 million service robots for personal and domestic use were sold, 28 % more than in 2012. The value of sales increased to \$1,7 billion. Service robots for personal and domestic use are recorded separately, as their unit value is generally only a fraction of that of many types of service robots for professional use. They are also produced for a mass market with different pricing and marketing channels.

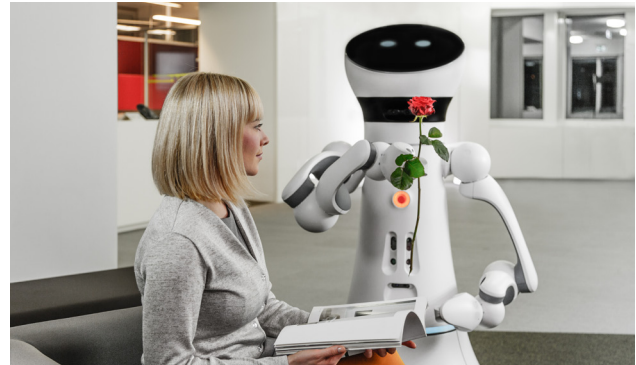

Figure 1: The touchscreen on the robot's head gives it a friendly and likeable mannerisms, but lets it also be easily controlled (Photo: Fraunhofer IPA)

So far, service robots for personal and domestic use are employed mainly in the areas of domestic robots, which include vacuum and floor cleaning, lawn-mowing robots, and entertainment and leisure robots, including toy robots, hobby systems, education, and research. Handicap assistance robots have taken off to the anticipated degree in the past few years. In 2013, a total of about 700 robots were sold, up from 160 in 2012 – an increase of 345 %. It is projected that sales of all types of robots for domestic tasks could reach almost 23,9 million units in the period 2014 to 2017, with an estimated value of \$6,5 billion. Sales of robots for elderly and handicap assistance will be about 12 400 units in the same period. This market is expected to increase substantially within the next 20 years.

Different requirements for industrial and service robots

Industrial and service robots differ significantly in terms of specifications. This can be seen when the required positioning accuracy is considered, or how the robots are integrated into the overall system. While traditional industrial robots perform their tasks in clearly structured environments with external safeguards, service robots usually work in unstructured environments and collaborate directly with humans. While industrial robots are made safe by being deactivated when somebody comes close, service robots have to interact with people. As a result, they require more complex safety concepts in order to ensure safe operation, perhaps even going as far as proximity sensors and tactile skin. Professor Gordon Cheng at the Technical University Munich has been constructing a sensitive skin for robots that will enable close contact between robots and humans. It can also be used in

exoskeletons, where the artificial skin gives feedback to the person in the exoskeleton. Amazingly, the researchers found that the brain can adapt to this kind of feedback and help people walk.

Industrial safety standards can be applied to service robotics wherever it makes sense to do so. However, at the same time they must not be overdone and end up running up exorbitant costs. Some smaller aspects, such as gripping technology and kinematics, can be applied to service robotics applications relatively easily. The manufacturer needs to consider the far more varied requirements of service robotics. The line between industrial and service robots has already become blurred in areas such as the automotive industry, for example.

Industrial robots that can build a car or assist a worker in building a car, can also help in everyday situations. Schunk is one of the pioneers in the field of mobile gripping systems. The company's portable grippers and lightweight arms have been pivotal in the field of service robotics. Dr. Markus Klaiber, Technical Director at Schunk said, "We are also working intensively on seeing grippers. This principle has already been put into practice with the one-finger hand of the Care-O-bot 4, which was developed by the Fraunhofer IPA Institute in Stuttgart in partnership with Schunk." It can be fitted with a built-in hand camera that allows users to view dimly lit areas on high shelves, for example.

This modular, multi-functional robot assistant is one example for a domestic service robot. Like other service

robots, all actuators of the Care-O-bot 4 are controlled via CANopen. Schunk Powerball ERB modules are used as arm joints. They control the movements of two axes in a single module with minimum space requirements. The modules also supply high torques and communicate via CANopen. The Care-O-bot 4 is a mobile robot assistant that is supposed to actively support humans in their daily life. It can be used for a variety of household tasks, for example to deliver food and drinks, to assist with cooking, or for cleaning. The robot can also be applied to a variety of services outside the home: to support patients and personnel in health care institutions, to deliver orders in restaurants, to provide reception and room service in hotels or for entertainment. Unstructured environments are still a problem for the robot, which is why it cannot be used in households yet. This is mainly a software problem though, according to the company, the hardware is ready.



Figure 2: A built-in camera transforms the one-finger hand of the Care-O-bot 4 into a seeing gripper (Photo: Fraunhofer IPA)

Annegret Emerich

CBM 8

THE VERSATILE CAN KEYPAD



TRY ME!

cbm8.electrumab.se

- CAN-OPEN SLAVE
- AMBIENT LIGHT SENSOR
- CUSTOMIZABLE SYMBOL PANEL
- HANDHELD OR PANEL MOUNTED
- OPTIONAL ANALOG I/O CONNECTOR
- USER FRIENDLY ONLINE CONFIGURATOR
- MORE THAN 16 MILLION COLORS AVAILABLE
- INTERNAL BUZZER FOR ENHANCED FEEDBACK

Release in Q3 2015 (prototypes available)

Round the world with a green motorbike racer



Since French novelist Jules Verne first envisioned going round the world in 80 days in 1873, it has been done many times, but rarely in an environmentally friendly way. That's what Storm Eindhoven intends to do in the 80 Day Race.

Only renewable energy can be used in the 80 Day Race. Teams will race between eight locations around the world without using a single drop of fossil fuel. The competing teams will choose their own routes and means of transport between eight stopovers. For the first edition, all land-based vehicles are allowed as long as they run on renewable resources and have no combustion engine.

The project is inspired by Jules Verne's book 'Around the world in 80 days', betting that new means of transportation make it possible to achieve this challenge. At that time – in 1873 – horses were about to be replaced by steam-powered vehicles. Today, we're facing another tipping point with the first mass market electric vehicles being available.

The teams will start in Europe and will head east in the direction of China. Each team is free to choose its own route, to make the adventure even greater. From Asia, the teams will cross the North Pacific Ocean to arrive at the west coast of North America where the half way mark will be celebrated. Teams race through a variety of landscapes towards the east coast of South America, before heading back to Europe. The race will commence on April 3, 2016.

Building a green motorcycle

Storm Eindhoven is in the process of building an electric motorcycle to take part in the race. Features of the ground-up design include optimized aerodynamics to minimize energy loss, smart refueling, automatic suspension adjustment, safety, and driver assistance systems. "We didn't want to be bound by current perceptions. By designing it completely from scratch we have been able to design a more ideal elec-

tric motorcycle. For example, we designed the chassis in-house to make room for our innovative modular battery pack. The electric engine we'll use already exists but it is being customized to our requirements and other parts – including the transmission and body – have been custom-designed for us by different partners," explained Bob de Vries, Software Engineer for Storm Eindhoven.

A particularly important feature of the electric cruiser is ruggedness. "We'll go through a lot of terrain types with extreme variations. The exact route isn't known but is likely to encompass everything from rainforest to barren desert," noted de Vries. With some 40 000 km to cover in 80 days, every part of the motorcycle will be tested to breaking point, including the electrical network. "We'll use the Kvaser USBcan Professional to ensure robustness, at least in the CAN network," he said.

Most of the motorcycle's communication goes through CAN, including critical messages such as battery temperature, battery state and regenerative braking. The software team will use the Kvaser USBcan Professional to ensure that the CAN network is doing exactly what's expected. The USBcan Professional is a two channel CAN interface with a standard USB 1.1 connection. It enables several interfaces to be connected to a PC. "We want to check if the messages on the CAN network correspond with the messages we send and check how saturated the network is, in order to prevent collisions. Kvaser's decoding mechanisms make it easy to spot strange behavior", said de Vries.

Explaining why Storm Eindhoven chose the Kvaser USBcan Professional, de Vries remarked: "The USBcan Professional is a plug and play solution. A big plus for us is that



Figure 1: The USBcan Professional has two high-speed channels with ISO 11898-2 compliant CAN transceivers, 10 kbit/s up to 1 Mbit/s (Photo: Kvaser)

it timestamps and synchronizes messages with a precision of 2 ms, enabling us to see precisely whether messages are sent in the right order. This allows us to find problems and identify the boundaries of time-critical functions.”

The system’s main controller is tasked with storing as much information as possible so that during the race, this information can be used to monitor the system-level health of the motorcycle. Wireless telemetry enables all the motorcycle’s data to be relayed to the service convoy in real-time. This will be used to predict part failures so that a service vehicle can be sent with correct replacement parts in advance. System-level health monitoring will also play a part in maximizing battery use. For example, the team will be able to monitor individual battery health and ascertain when they need to be swapped for newly charged cartridges, or indeed, replaced when they have lost too much capacity.

Storm’s electric touring motorcycle is not intended to be just another prototype. Ultimately, the Dutch team intends to build a series of four consumer-ready motorcycles, making the entire round-the-world event a ‘living lab’ in which each innovation is put to the test under the harshest of conditions.



Figure 2: Storm Eindhoven consists of 29 students who are still looking for sponsors (Photo: Storm)

Storm Eindhoven consists of 29 students who voluntarily dedicate two years of their work to Storm in order to achieve their shared goal of winning the 80 Day Race. Nearly every discipline the Eindhoven University of Technology offers is represented in the team.



Author

Vanessa Knivett
 Kvaser
www.kvaser.com
 Storm Eindhoven
www.storm-eindhoven.com

Related link

[60 000 CAN nodes in one network](#)

QNX and PREEMPT_RT Linux

the stable and reliable real-time platform for embedded & distributed systems

CAN | CANopen® | J1939

DACHS®

Distributed Automation Control System

Standard DACHS® products for CAN

- CAN Layer2, CANopen, and J1939 in real-time
- high performance drivers and APIs
- CANopen stack with sources
- IEC 61131-3 / IEC 61499 programming
- **DACHSVIEW++** with C/C++ JIT Compiler

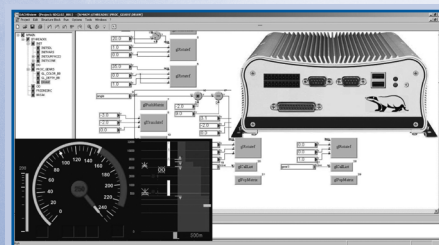

supported boards:

PC/104, PC/104-Plus, PCI, PCIe, ISA, SoCs

supported CAN controllers:

SJA 1000, i82527 or Bosch CC770, msCAN, HECC, TouCAN, etc.
 for x86, PPC, ARM9, etc.

OEM solutions and adaption for OEM platforms

CONSULTING & ENGINEERING



+49 (0)64 31-52 93 66 · info@steinhoff-automation.com
www.steinhoff-automation.com · www.dachs.info

FLEXIBLE | RELIABLE | INNOVATIVE | EMBEDDED
PC-BASED | REAL-TIME | FIELDBUSES

DACHS® Product Suite, support worldwide, consulting & engineering
 DACHS and the DACHS logo are registered trademarks of Steinhoff A.
 All other trademarks belong to their respected owners.

E-quad: driving e-mobility forward

In Germany, electric motorbikes are still a niche market, even though they bring out the full benefits of electric motors. Their weaknesses, such as their lengthy refueling time and short range, are of only minor significance in comparison.



Gigatronik, an ECU development specialist in the automotive sector, is committed to a long-term in-house project, which is intended to electrify this vehicle segment. An interdisciplinary team of staff and students has developed an electro-mobile all-terrain vehicle (an “e-quad”), which also serves as a platform and training medium. The quad was a deliberate choice: as an all-terrain, sport, and recreational vehicle, it was selected in order to bring out the strengths of the electric drive, not least in terms of driving experience; and also to create further incentives for electrification. Other future-orientated functions, such as torque vectoring, driving slip control, and sound generation, should also enhance and drive forward development and interest in electric mobility.

A conventional combustion-engine quad is used as a basis for the development of the e-quad. The drive train was replaced by electric drives with power electronics, a power supply, a cable set, display, and control units; mainly incorporating the company’s in-house developed components. Additional data can be displayed, using a Bluetooth-tablet to receive both vehicle data and the driver’s vital signs.

Four independent wheel drives

The e-quad is propelled by four brush-less DC motors – one for each of its wheels, linked to the respective drive shaft by a transmission. Hence, the e-quad is an independen-

dent wheel drive vehicle. It was designed for a speed of 50 km/h with continuous mechanical power of approximately 20 kW. Four Gigatronik motor controllers (Power Stage) handle control of the drive motors, based on the principle of field-orientated control. For drive optimization, additional field weakening has been integrated, which enables the engine to provide torque even at higher speeds. The rotation angles of the individual brushless DC motors are measured by Hall sensors, with these values being read into the motor controllers.

The independence of all four wheel drives enables longitudinal and lateral dynamics to be controlled much more flexibly than with conventional vehicles. In this way, torque vectoring, ESC (Electronic Stability Control), and autonomous steering can be implemented exclusively through corresponding actuation of the individual motors.

48-V electrical system

Four lithium-ion batteries with integrated battery management provide the e-quad’s power supply. Their total capacity of 126 Ah ensures a range of about 40 km. The batteries are connected in parallel across a management system and thus form a 48-V low-voltage power network for the four electric motors. As a safe and reliable alternative to high-voltage systems, this 48-V electrical system is increasingly attracting attention in the vehicle sector. ▶

ifm electronic



Your engine has been talking
to you for years...

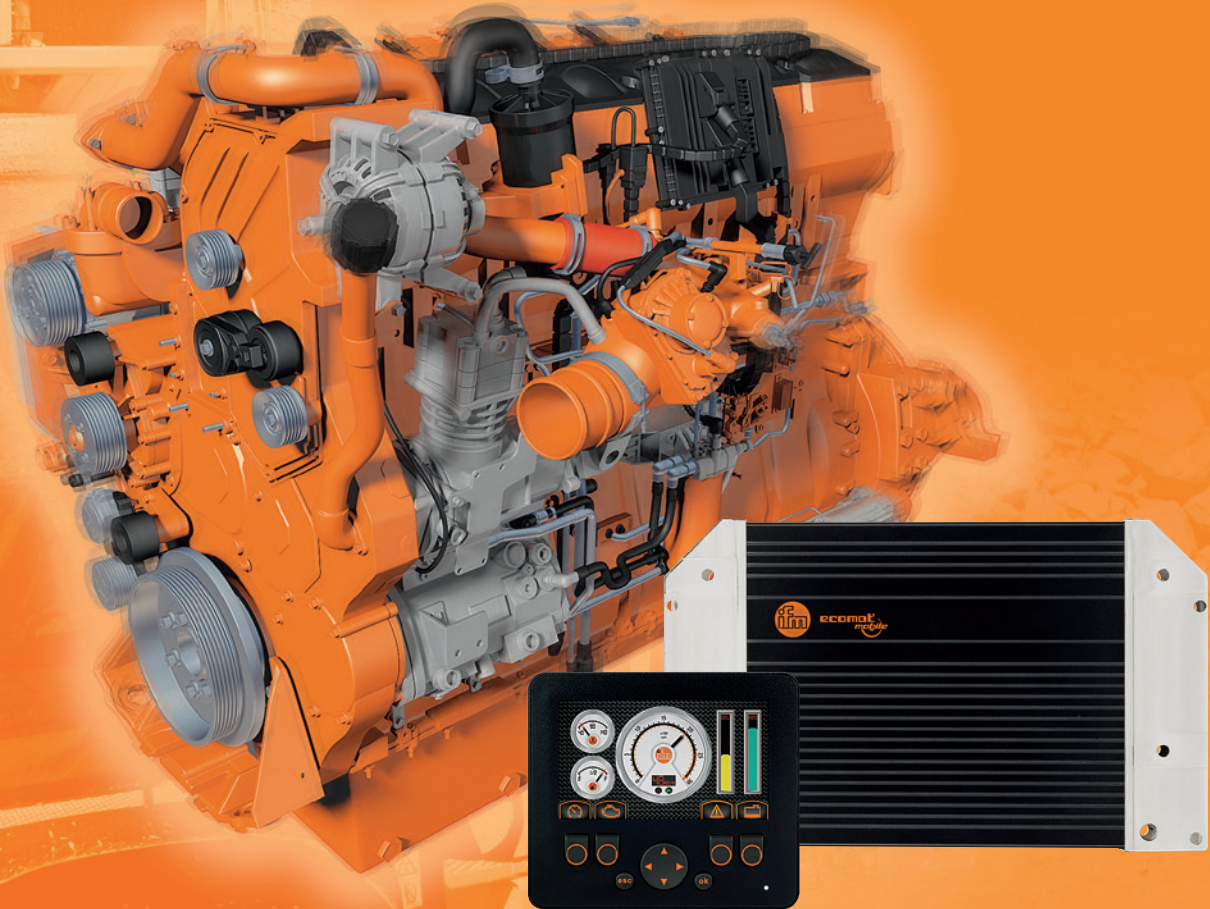

...now it's time to listen.

ifm mobile controllers and displays – connection via SAE J1939 allows both reading data and controlling the engine.
All devices are freely programmable to IEC61131-3 with CODESYS.
Pre-written SAE J1939 libraries to aid with software development.
Compliant to Tier 3, Tier 4 and Tier 4 final as well as up to Euro 6.

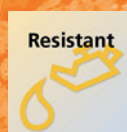
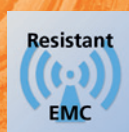

ifm – close to you!

www.ifm.com/gb/j1939

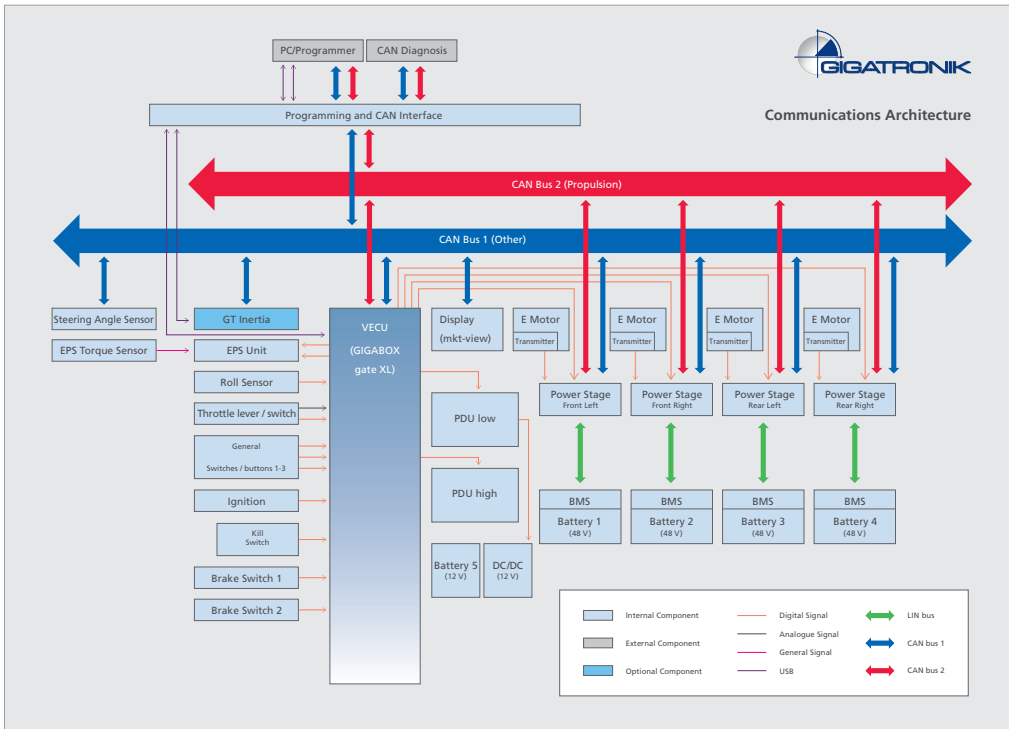

Figure 1: Communications architecture of the system components of the e-quad (Photo: Gigatronik)

Communications architecture

The traction control devices and components of the e-quad are connected via high-speed CAN networks and LIN bus. Figure 1 shows the communications architecture of all system components, including a USB link conveying programming and other communication signals.

A Vehicle Control Unit (VECU) serves as the central, high-level master control unit. For this, the Gigabox Gate XL control unit was used, which is the most powerful version of the company's product line. A separate CAN network for propulsion (CAN 2) networks the VECU with the four Power Stage motor controllers.

The driver's display is connected to CAN 1 and shows the current battery level, a diagnostic overview, as well as the date, time, speed, total mileage, temporary mileage, and day/night driving mode. Optionally, a telematics control unit can be integrated into CAN 1. In the inertia controller used here, which features GPS capability and a 6D sensor module, inertial data is collected and preprocessed for the purpose of controlling lateral dynamics.



Figure 2: Display on tablet or smartphone (Photo: Gigatronik)

E-quad app for Android

Tablets and smartphones are planned as an additional interface providing the user with a range of control and display options. For this purpose, the communications architecture has been expanded by a Bluetooth/CAN gateway (Bluetooth Low Energy 4.0). Gigatronik has also developed an Android app, which can be used as a control center for vehicle functions and monitoring of the driver's vital signs (see Figure 2). This app is linked via Bluetooth to the VECU Gigabox Gate XL.

As an instrument cluster and infotainment system linked to the e-quad, the app currently offers the following functions:

- ◆ Display of vehicle data, such as speed, battery power, and battery status,
- ◆ Drive control,
- ◆ Google Maps function,
- ◆ Vital signs monitoring, eCall function.

The app has been implemented for demonstration purposes for tablets and can be transferred to smartphones.

View to the future

The components used are subject to continuous development. Thus, a power electronics unit with double the power is currently under development; and this holds out the promise of even greater driving pleasure in the future. Thanks to the flexible drive concept, the e-quad is also an ideal basis for developing automated driving functions: automatic parking, adaptive cruise control and lane-keeping are all essential features for a fully autonomous vehicle, and they are next in line for implementation.

Author

Dr. Gunter Wiedemann
Gigatronik Stuttgart
www.gigatronik.com



CAN-PCIe/402

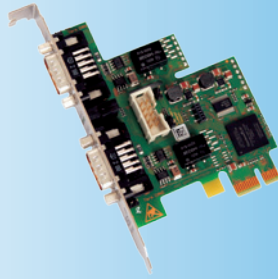

CAN-PCIe/402

- up to 4 high performance PCI Express CAN interfaces
- DMA busmaster
- Powered by esd Advanced CAN Core (esd-ACC)
- MSI (Message Signaled Interrupt) support
- Electrically isolated
- Provides high resolution hardware timestamp

CAN-USB/400



CAN-USB/400

- 2 high performance CAN-USB interfaces
- Powered by esd Advanced CAN Core (esd-ACC)
- USB 2.0 with high speed data rates of 480 Mbit/s
- Electrically isolated
- Provides high resolution hardware timestamp
- Error injection for advanced diagnostic
- IRIB B timecode as option

CAN-PCI/400



CAN-PCI/400

- up to 4 high performance CAN interfaces
- Powered by esd Advanced CAN Core (esd-ACC)
- Electrically isolated
- Provides high resolution hardware timestamp
- Error injection for advanced diagnostic

Ethernet



CAN-PCI104/200

- PCI104-CAN interface
- One or two CAN interfaces for PCI104 bus

EtherCAN/2

- 10/100 BaseT ETHERNET-CAN Gateway
- Electrically isolated
- Configuration and Diagnostics by webbrowser

CAN-USB/2



CAN-USB/2

- CAN-USB interface
- Intelligent CAN interface with ARM 7
- USB 2.0 with high speed data rates of 480 Mbit/s
- Electrically isolated
- Provides high resolution hardware timestamp

Gateways

- EtherCAT-CAN
- PROFINET-CANopen
- PROFIBUS-CANopen
- PROFIBUS-DeviceNet
- EtherNet/S7-CAN

Operating Systems

esd supports the real-time multitasking operating systems VxWorks, QNX, RTX, RTOS-32 and others as well as Linux and Windows 32/64Bit systems

Gateways



CAN Tools

- CANreal: Display and recording of CAN message frames
- CANplot: Display of online/offline CAN data
- CANrepro: Replay of pre-recorded CAN message frames
- CANscript: Python scripting tool to handle CAN messages
- COBview: Analysis and diagnostics of CANopen nodes

The tools are free of charge on the driver CD or can be downloaded at www.esd.eu





Solutions for Open Networks from one Source

Open CAN-based protocols are the basis of networking in commercial vehicles, avionics and industrial control technology. Vector supports you in all development phases of these systems:

- > Systematic network design with CANoe, ProCANopen and CANeds
- > Successful implementation with source code for J1939 and more
- > Efficient configuration, test and extensive analysis with ProCANopen, CANoe and CANalyzer

Multifaceted trainings and individual consulting complete our extensive offerings.

Thanks to the close interlocking of the Vector tools and the competent support, you will increase the efficiency of your entire development process from design to testing.

- ▶ **Further information, application notes and demos:**
www.vector.com/opennetworks